



Local Public Agency
Formal Contract Proposal

PROPOSAL SUBMITTED BY		
Contractor's Name		
Street	P.O. Box	
City	State	Zip Code

STATE OF ILLINOIS

COUNTY OF DeKalb
Sycamore Road District
 (Name of City, Village, Town or Road District)

FOR THE IMPROVEMENT OF

STREET NAME OR ROUTE NO. Various Roads
 SECTION NO. 14-18000-02-GM
 TYPES OF FUNDS MFT

SPECIFICATIONS (required)

PLANS (required)

For Municipal Projects
 Submitted/Approved/Passed

Mayor President of Board of Trustees Municipal Official

Date

Department of Transportation

Released for bid based on limited review

Regional Engineer

Date

For County and Road District Projects
 Submitted/Approved

Highway Commissioner

Date

Submitted/Approved

County Engineer/Superintendent of Highways

Date

Note: All proposal documents, including Proposal Guaranty Checks or Proposal Bid Bonds, should be stapled together to prevent loss when bids are processed.

RETURN WITH BID

NOTICE TO BIDDERS

County DeKalb
Local Public Agency Sycamore Road District
Section Number 14-18000-02-GM
Route Various Roads

Sealed proposals for the improvement described below will be received at the office of the DeKalb County Engineer, 1826 Barber Greene Road, DeKalb, IL 60115 until 10:00 AM on April 3, 2014

Sealed proposals will be opened and read publicly at the office of the DeKalb County Engineer 1826 Barber Greene Road, DeKalb, IL 60115 at 10:00 AM on April 3, 2014

DESCRIPTION OF WORK

Name Various Roads Length: 11840.00 feet (2.24 miles)
Location Various locations in Sycamore Township
Proposed Improvement HMA overlay with other incidental work

1. Plans and proposal forms will be available in the office of the DeKalb County Engineer 1826 Barber Greene Road, DeKalb, IL 60115

2. [X] Prequalification
If checked, the 2 low bidders must file within 24 hours after the letting an "Affidavit of Availability" (Form BC 57), in duplicate, showing all uncompleted contracts awarded to them and all low bids pending award for Federal, State, County, Municipal and private work.

3. The Awarding Authority reserves the right to waive technicalities and to reject any or all proposals as provided in BLRS Special Provision for Bidding Requirements and Conditions for Contract Proposals.

4. The following BLR Forms shall be returned by the bidder to the Awarding Authority:
a. BLR 12200: Local Public Agency Formal Contract Proposal
b. BLR 12200a Schedule of Prices
c. BLR 12230: Proposal Bid Bond (if applicable)
d. BLR 12325: Apprenticeship or Training Program Certification (do not use for federally funded projects)
e. BLR 12326: Affidavit of Illinois Business Office

5. The quantities appearing in the bid schedule are approximate and are prepared for the comparison of bids. Payment to the Contractor will be made only for the actual quantities of work performed and accepted or materials furnished according to the contract.

6. Submission of a bid shall be conclusive assurance and warranty the bidder has examined the plans and understands all requirements for the performance of work. The bidder will be responsible for all errors in the proposal resulting from failure or neglect to conduct an in depth examination.

7. The bidder shall take no advantage of any error or omission in the proposal and advertised contract.

8. If a special envelope is supplied by the Awarding Authority, each proposal should be submitted in that envelope furnished by the Awarding Agency and the blank spaces on the envelope shall be filled in correctly to clearly indicate its contents. When an envelope other than the special one furnished by the Awarding Authority is used, it shall be marked to clearly indicate its contents.

9. Permission will be given to a bidder to withdraw a proposal if the bidder makes the request in writing or in person before the time for opening proposals.

RETURN WITH BID

PROPOSAL

County DeKalb
Local Public Agency Sycamore Road District
Section Number 14-18000-02-GM
Route Various Roads

1. Proposal of _____
for the improvement of the above section by the construction of HMA overlay with other incidental work on
various roads throughout Sycamore Township

a total distance of 11840.00 feet, of which a distance of 11740.00 feet, (2.223 miles) are to be improved.

2. The plans for the proposed work are those prepared by the DeKalb County Highway Department
and approved by the Department of Transportation on _____

3. The specifications referred to herein are those prepared by the Department of Transportation and designated as
Standard Specifications for Road and Bridge Construction and the Supplemental Specifications and Recurring Special
Provisions thereto, adopted and in effect on the date of invitation for bids.

4. The undersigned agrees to accept, as part of the contract, the applicable Special Provisions indicated on the Check
Sheet for Recurring Special Provisions contained in this proposal.

5. The undersigned agrees to complete the work within 20 working days or by _____
unless additional time is granted in accordance with the specifications.

6. A proposal guaranty in the proper amount, as specified in BLRS Special Provision for Bidding Requirements and
Conditions for Contract Proposals, will be required. Bid Bonds will be allowed as a proposal guaranty. Accompanying this
proposal is either a bid bond if allowed, on Department form BLR 12230 or a proposal guaranty check, complying with the
specifications, made payable to:

the DeKalb County Treasurer of _____

The amount of the check is _____ (_____).

7. In the event that one proposal guaranty check is intended to cover two or more proposals, the amount must be equal to
the sum of the proposal guaranties, which would be required for each individual proposal. If the proposal guaranty check
is placed in another proposal, it will be found in the proposal for: Section Number _____.

8. The successful bidder at the time of execution of the contract will be required to deposit a contract bond for the full
amount of the award. When a contract bond is not required, the proposal guaranty check will be held in lieu thereof. If this
proposal is accepted and the undersigned fails to execute a contract and contract bond as required, it is hereby agreed
that the Bid Bond or check shall be forfeited to the Awarding Authority.

9. Each pay item should have a unit price and a total price. If no total price is shown or if there is a discrepancy between the
product of the unit price multiplied by the quantity, the unit price shall govern. If a unit price is omitted, the total price will
be divided by the quantity in order to establish a unit price.

10. A bid will be declared unacceptable if neither a unit price nor a total price is shown.

11. The undersigned submits herewith the schedule of prices on BLR 12200a covering the work to be performed under this
contract.

12. The undersigned further agrees that if awarded the contract for the sections contained in the combinations on
BLR 12200a, the work shall be in accordance with the requirements of each individual proposal for the multiple bid
specified in the Schedule for Multiple Bids below.

RETURN WITH BID

CONTRACTOR CERTIFICATIONS

County	<u>DeKalb</u>
Local Public Agency	<u>Sycamore Road District</u>
Section Number	<u>14-18000-02-GM</u>
Route	<u>Various Roads</u>

The certifications hereinafter made by the bidder are each a material representation of fact upon which reliance is placed should the Department enter into the contract with the bidder.

1. **Debt Delinquency.** The bidder or contractor or subcontractor, respectively, certifies that it is not delinquent in the payment of any tax administered by the Department of Revenue unless the individual or other entity is contesting, in accordance with the procedures established by the appropriate revenue Act, its liability for the tax or the amount of tax. Making a false statement voids the contract and allows the Department to recover all amounts paid to the individual or entity under the contract in a civil action.

2. **Bid-Rigging or Bid Rotating.** The bidder or contractor or subcontractor, respectively, certifies that it is not barred from contracting with the Department by reason of a violation of either 720 ILCS 5/33E-3 or 720 ILCS 5/33E-4.

A violation of Section 33E-3 would be represented by a conviction of the crime of bid-rigging which, in addition to Class 3 felony sentencing, provides that any person convicted of this offense or any similar offense of any state or the United States which contains the same elements as this offense shall be barred for 5 years from the date of conviction from contracting with any unit of State or local government. No corporation shall be barred from contracting with any unit of State or local government as a result of a conviction under this Section of any employee or agent of such corporation if the employee so convicted is no longer employed by the corporation and: (1) it has been finally adjudicated not guilty or (2) if it demonstrates to the governmental entity with which it seeks to contract and that entity finds that the commission of the offense was neither authorized, requested, commanded, nor performed by a director, officer or a high managerial agent in behalf of the corporation.

A violation of Section 33E-4 would be represented by a conviction of the crime of bid-rotating which, in addition to Class 2 felony sentencing, provides that any person convicted of this offense or any similar offense of any state or the United States which contains the same elements as this offense shall be permanently barred from contracting with any unit of State or local government. No corporation shall be barred from contracting with any unit of State or local government as a result of a conviction under this Section of any employee or agent of such corporation if the employee so convicted is no longer employed by the corporation and: (1) it has been finally adjudicated not guilty or (2) if it demonstrates to the governmental entity with which it seeks to contract and that entity finds that the commission of the offense was neither authorized, requested, commanded, nor performed by a director, officer or a high managerial agent in behalf of the corporation.

3. **Bribery.** The bidder or contractor or subcontractor, respectively, certifies that it has not been convicted of bribery or attempting to bribe an officer or employee of the State of Illinois or any unit of local government, nor has the firm made an admission of guilt of such conduct which is a matter of record, nor has an official, agent, or employee of the firm committed bribery or attempted bribery on behalf of the firm and pursuant to the direction or authorization of a responsible official of the firm.

4. **Interim Suspension or Suspension.** The bidder or contractor or subcontractor, respectively, certifies that it is not currently under a suspension as defined in Subpart I of Title 44 Subtitle A Chapter III Part 6 of the Illinois Administrative Code. Furthermore, if suspended prior to completion of this work, the contract or contracts executed for the completion of this work may be cancelled.

RETURN WITH BID

SIGNATURES

County DeKalb
Local Public Agency Sycamore Road District
Section Number 14-18000-02-GM
Route Various Roads

(If an individual)

Signature of Bidder

Business Address

(If a partnership)

Firm Name

Signed By

Business Address

Inset Names and Addressed of All Partners



(If a corporation)

Corporate Name

Signed By

President

Business Address

Inset Names of Officers



President

Secretary

Treasurer

Attest: Secretary



Local Agency Proposal Bid Bond

Route Various Roads
County DeKalb
Local Agency Sycamore Road District
Section 14-18000-02-GM

RETURN WITH BID

PAPER BID BOND

WE _____ as PRINCIPAL,
and _____ as SURETY,

are held jointly, severally and firmly bound unto the above Local Agency (hereafter referred to as "LA") in the penal sum of 5% of the total bid price, or for the amount specified in the proposal documents in effect on the date of invitation for bids whichever is the lesser sum. We bind ourselves, our heirs, executors, administrators, successors, and assigns, jointly pay to the LA this sum under the conditions of this instrument.

WHEREAS THE CONDITION OF THE FOREGOING OBLIGATION IS SUCH that, the said PRINCIPAL is submitting a written proposal to the LA acting through its awarding authority for the construction of the work designated as the above section.

THEREFORE if the proposal is accepted and a contract awarded to the PRINCIPAL by the LA for the above designated section and the PRINCIPAL shall within fifteen (15) days after award enter into a formal contract, furnish surety guaranteeing the faithful performance of the work, and furnish evidence of the required insurance coverage, all as provided in the "Standard Specifications for Road and Bridge Construction" and applicable Supplemental Specifications, then this obligation shall become void; otherwise it shall remain in full force and effect.

IN THE EVENT the LA determines the PRINCIPAL has failed to enter into a formal contract in compliance with any requirements set forth in the preceding paragraph, then the LA acting through its awarding authority shall immediately be entitled to recover the full penal sum set out above, together with all court costs, all attorney fees, and any other expense of recovery.

IN TESTIMONY WHEREOF, the said PRINCIPAL and the said SURETY have caused this instrument to be signed by their respective officers this _____ day of _____

Principal

(Company Name)
By: _____ (Signature and Title)

(If PRINCIPLE is a joint venture of two or more contractors, the company names, and authorized signatures of each contractor must be affixed.)

Surety

(Name of Surety)
By: _____ (Signature of Attorney-in-Fact)

STATE OF ILLINOIS,
COUNTY OF _____
I, _____, a Notary Public in and for said county,
do hereby certify that _____

(Insert names of individuals signing on behalf of PRINCIPAL & SURETY)

who are each personally known to me to be the same persons whose names are subscribed to the foregoing instrument on behalf of PRINCIPAL and SURETY, appeared before me this day in person and acknowledged respectively, that they signed and delivered said instruments as their free and voluntary act for the uses and purposes therein set forth.

Given under my hand and notarial seal this _____ day of _____

My commission expires _____ (Notary Public)

ELECTRONIC BID BOND

[X] Electronic bid bond is allowed (box must be checked by LA if electronic bid bond is allowed)
The Principal may submit an electronic bid bond, in lieu of completing the above section of the Proposal Bid Bond Form. By providing an electronic bid bond ID code and signing below, the Principal is ensuring the identified electronic bid bond has been executed and the Principal and Surety are firmly bound unto the LA under the conditions of the bid bond as shown above. (If PRINCIPAL is a joint venture of two or more contractors, an electronic bid bond ID code, company/Bidder name title and date must be affixed for each contractor in the venture.)

Electronic Bid Bond ID Code

(Company/Bidder Name)
(Signature and Title)
Date



Return with Bid

Route	<u>Various Roads</u>
County	<u>DeKalb</u>
Local Agency	<u>Sycamore Road District</u>
Section	<u>14-18000-02-GM</u>

All contractors are required to complete the following certification:

- For this contract proposal or for all groups in this deliver and install proposal.
- For the following deliver and install groups in this material proposal:

Illinois Department of Transportation policy, adopted in accordance with the provisions of the Illinois Highway Code, requires this contract to be awarded to the lowest responsive and responsible bidder. The award decision is subject to approval by the Department. In addition to all other responsibility factors, this contract or deliver and install proposal requires all bidders and all bidders' subcontractors to disclose participation in apprenticeship or training programs that are (1) approved by and registered with the United States Department of Labor's Bureau of Apprenticeship and Training, and (2) applicable to the work of the above indicated proposals or groups. Therefore, all bidders are required to complete the following certification:

- I. Except as provided in paragraph IV below, the undersigned bidder certifies that it is a participant, either as an individual or as part of a group program, in an approved apprenticeship or training program applicable to each type of work or craft that the bidder will perform with its own employees.
- II. The undersigned bidder further certifies for work to be performed by subcontract that each of its subcontractors submitted for approval either (A) is, at the time of such bid, participating in an approved, applicable apprenticeship or training program; or (B) will, prior to commencement of performance of work pursuant to this contract, establish participation in an approved apprenticeship or training program applicable to the work of the subcontract.
- III. The undersigned bidder, by inclusion in the list in the space below, certifies the official name of each program sponsor holding the Certificate of Registration for all of the types of work or crafts in which the bidder is a participant and that will be performed with the bidder's employees. Types of work or craft that will be subcontracted shall be included and listed as subcontract work. The list shall also indicate any type of work or craft job category for which there is no applicable apprenticeship or training program available.

IV. Except for any work identified above, any bidder or subcontractor that shall perform all or part of the work of the contract or deliver and install proposal solely by individual owners, partners or members and not by employees to whom the payment of prevailing rates of wages would be required, check the following box, and identify the owner/operator workforce and positions of ownership.

The requirements of this certification and disclosure are a material part of the contract, and the contractor shall require this certification provision to be included in all approved subcontracts. The bidder is responsible for making a complete report and shall make certain that each type of work or craft job category that will be utilized on the project is accounted for and listed. The Department at any time before or after award may require the production of a copy of each applicable Certificate of Registration issued by the United States Department of Labor evidencing such participation by the contractor and any or all of its subcontractors. In order to fulfill the participation requirement, it shall not be necessary that any applicable program sponsor be currently taking or that it will take applications for apprenticeship, training or employment during the performance of the work of this contract or deliver and install proposal.

Bidder: _____

By: _____

(Signature)

Address: _____

Title: _____



Affidavit of Illinois Business Office

County DeKalb
Local Public Agency Sycamore Road District
Section Number 14-18000-02-GM
Route Various Roads

State of _____)
County of _____) ss.

I, _____ of _____, _____,
(Name of Affiant) (City of Affiant) (State of Affiant)

being first duly sworn upon oath, states as follows:

- 1. That I am the _____ of _____ bidder.
2. That I have personal knowledge of the facts herein stated.
3. That, if selected under this proposal, _____, will maintain a
business office in the State of Illinois which will be located in _____ County, Illinois.
4. That this business office will serve as the primary place of employment for any persons employed in the
construction contemplated by this proposal.
5. That this Affidavit is given as a requirement of state law as provided in Section 30-22(8) of the Illinois
Procurement Code.

(Signature)

(Print Name of Affiant)

This instrument was acknowledged before me on _____ day of _____, _____.

(SEAL)

(Signature of Notary Public)



Illinois Department of Transportation

Bureau of Construction
2300 South Dirksen Parkway/Room 322
Springfield, Illinois 62764

Affidavit of Availability For the Letting of 4/3/2014

Instructions: Complete this form by either typing or using black ink. "Authorization to Bid" will not be issued unless both sides of this form are completed in detail. Use additional forms as needed to list all work.

Part I. Work Under Contract

List below all work you have under contract as either a prime contractor or a subcontractor. It is required to include all pending low bids not yet awarded or rejected. In a joint venture, list only that portion of the work which is the responsibility of your company. The uncompleted dollar value is to be based upon the most recent engineer's or owners estimate, and must include work subcontracted to others. If no work is contracted, show **NONE**.

	1	2	3	4	Awards Pending	
Contract Number						
Contract With						
Estimated Completion Date						
Total Contract Price						Accumulated Totals
Uncompleted Dollar Value if Firm is the Prime Contractor						
Uncompleted Dollar Value if Firm is the Subcontractor						
Total Value of All Work						

Part II. Awards Pending and Uncompleted Work to be done with your own forces.

List below the uncompleted dollar value of work for each contract and awards pending to be completed with your own forces. All work subcontracted to others will be listed on the reverse of this form. In a joint venture, list only that portion of the work to be done by your company. If no work is contracted, show **NONE**.

						Accumulated Totals
Earthwork						
Portland Cement Concrete Paving						
HMA Plant Mix						
HMA Paving						
Clean & Seal Cracks/Joints						
Aggregate Bases & Surfaces						
Highway, R.R. and Waterway Structures						
Drainage						
Electrical						
Cover and Seal Coats						
Concrete Construction						
Landscaping						
Fencing						
Guardrail						
Painting						
Signing						
Cold Milling, Planning & Rotomilling						
Demolition						
Pavement Markings (Paint)						
Other Construction (List)						
Totals						

Disclosure of this information is **REQUIRED** to accomplish the statutory purpose as outlined in the "Illinois Procurement Code." Failure to comply will result in non-issuance of an "Authorization To Bid." This form has been approved by the State Forms Management Center.

Part III. Work Subcontracted to Others.

For each contract described in Part I, list all the work you have subcontracted to others.

	1	2	3	4	Awards Pending
Subcontractor					
Type of Work					
Subcontract Price					
Amount Uncompleted					
Subcontractor					
Type of Work					
Subcontract Price					
Amount Uncompleted					
Subcontractor					
Type of Work					
Subcontract Price					
Amount Uncompleted					
Subcontractor					
Type of Work					
Subcontract Price					
Amount Uncompleted					
Subcontractor					
Type of Work					
Subcontract Price					
Amount Uncompleted					
Subcontractor					
Type of Work					
Subcontract Price					
Amount Uncompleted					
Total Uncompleted					

I, being duly sworn, do hereby declare that this affidavit is a true and correct statement relating to ALL uncompleted contracts of the undersigned for Federal, State, County, City and private work, including ALL subcontract work, ALL pending low bids not yet awarded or rejected and ALL estimated completion dates.

Subscribed and sworn to before me
 this _____ day of _____, _____ Type or Print Name _____
 Officer or Director Title

 Notary Public

My commission expires _____

(Notary Seal)

Signed _____

Company _____

Address _____

DeKalb County
 Sycamore Road District
 Section 14-18000-02-GM

SUMMARY OF QUANTITIES

40600200	Bituminous Materials (Prime Coat)	TON	23
40600300	Aggregate (Prime Coat)	TON	38
40600982	Hot-Mix Asphalt Surface Removal – Butt Joint	SQ YD	3,556
40600615	Leveling Binder (Machine Method) FG, N30	TON	1,176
40603310	Hot-Mix Asphalt Surface Course, Mix C, N30	TON	3,460
70300100	Short Term Pavement Marking	FT	283

SCHEDULE OF QUANTITIES

Hot-Mix Asphalt Surface Removal – Butt Joint

Devine Way at Plank Rd	56 SY
Lukens Rd at Base Line Rd	49 SY
Lukens Rd at N ROW of RR	47 SY
Lukens Rd at S ROW of RR	47 SY
Lukens Rd at south end	143 SY
ForestView Dr at Brentwood Dr	51 SY
Maplewood Dr at east end	153 SY
Maplewood Dr at Prosser Dr	53 SY
Maplewood Dr at Oakland Dr	54 SY
Brickville Rd at south end	160 SY
Brickville Rd at Woodlawn Tr	53 SY
Brickville Rd at Birch Ln	53 SY
Primrose Ln at Route 23	71 SY
Primrose Ln along C&G	2,317 SY
North Grove Rd at west end	147 SY
North Grove Rd at Twin Oaks	53 SY
North Grove Rd at Brickville Rd	49 SY
<u>Driveways (to be done by others)</u>	<u>0 SY</u>
Total	3,556 SY

Hot-Mix Asphalt Surface Course, Mix C, N30

Driveways (100)	447 Ton
Sideroads (5)	45 Ton
<u>Mainline</u>	<u>2,968 Ton</u>
Total	3,460 Ton

Quantities are estimate prepared for the establishment of pay item prices and are the responsibility of the contractor to confirm prior to bidding. Quantities may be increased, decreased, or omitted to satisfactorily complete the project.

SYCAMORE TWP.

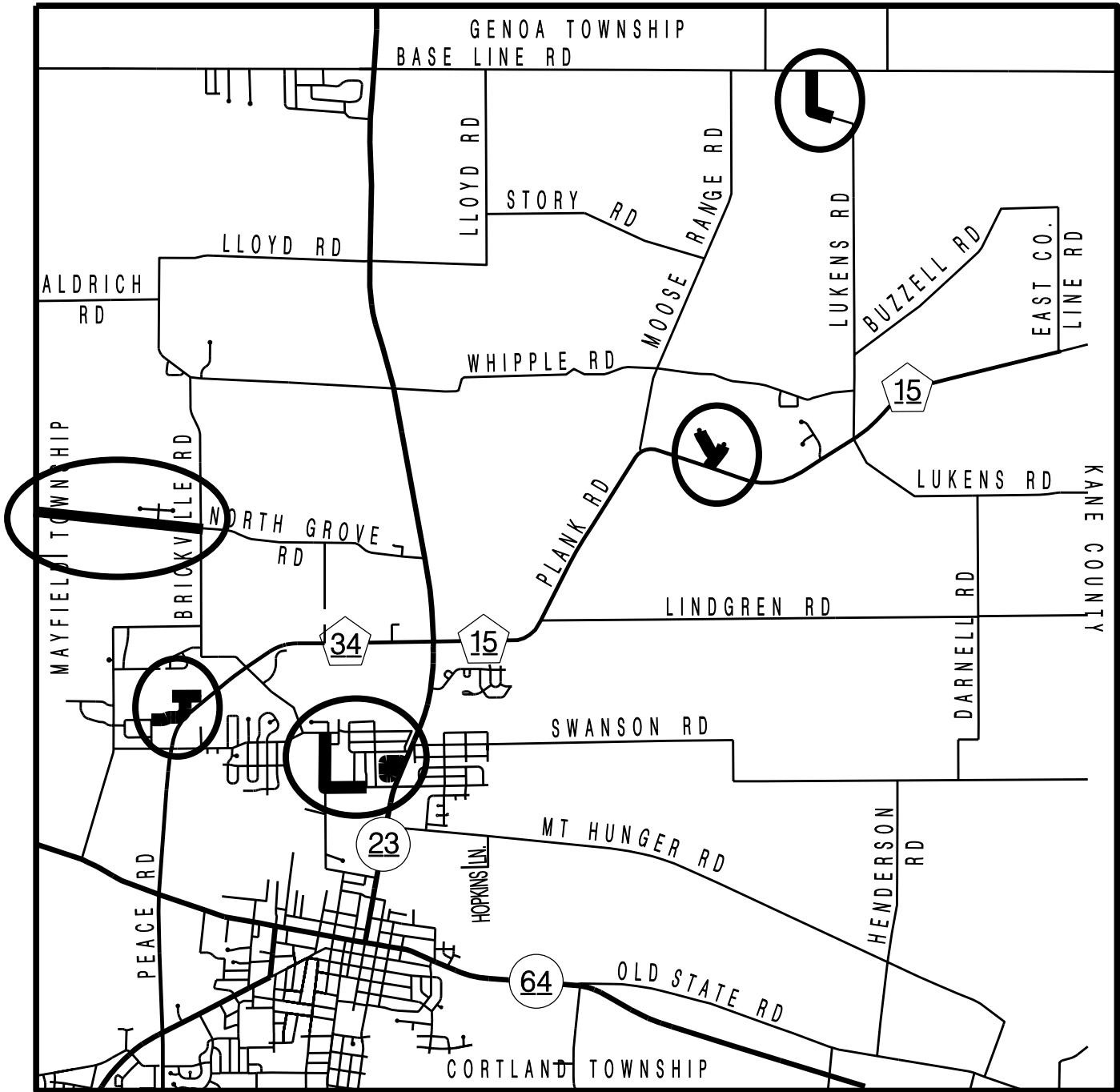
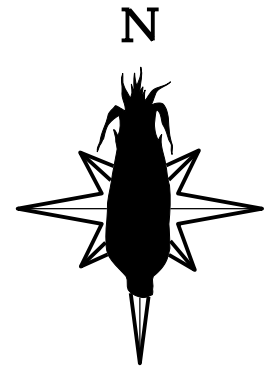

SECTION 14-18000-02-GM
SYCAMORE ROAD DISTRICT
LOCATION OF PROPOSED HOT MIX RESURFACING

TYPICAL SECTION

BRICKVILLE RD

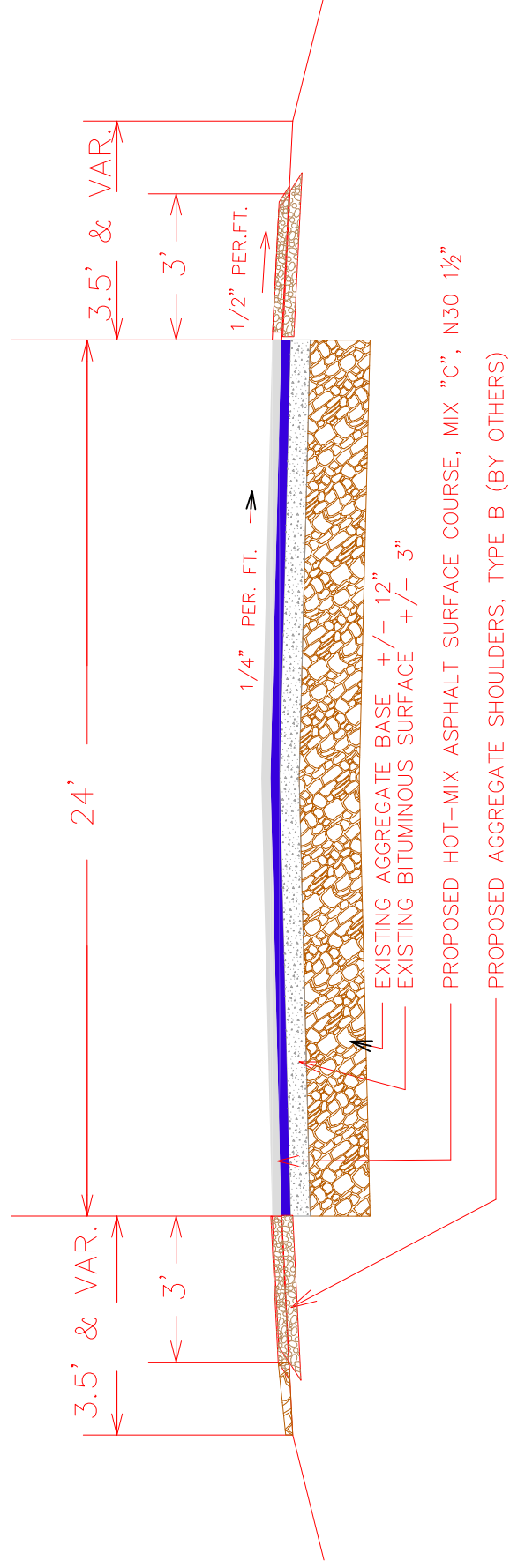

SECTION 14-18000-02-GM

TYPICAL SECTION

CHRISTINE DR, FOREST VIEW DR
MAPLEWOOD DR

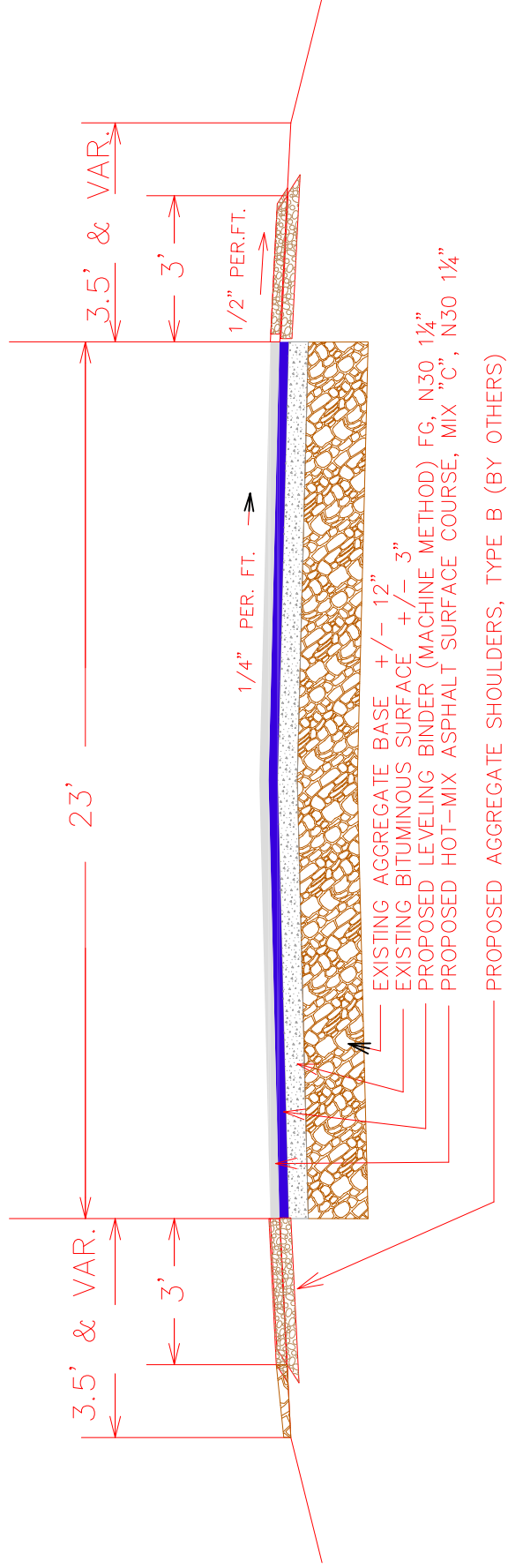

SECTION 14-18000-02-GM

TYPICAL SECTION

DEVINE WAY

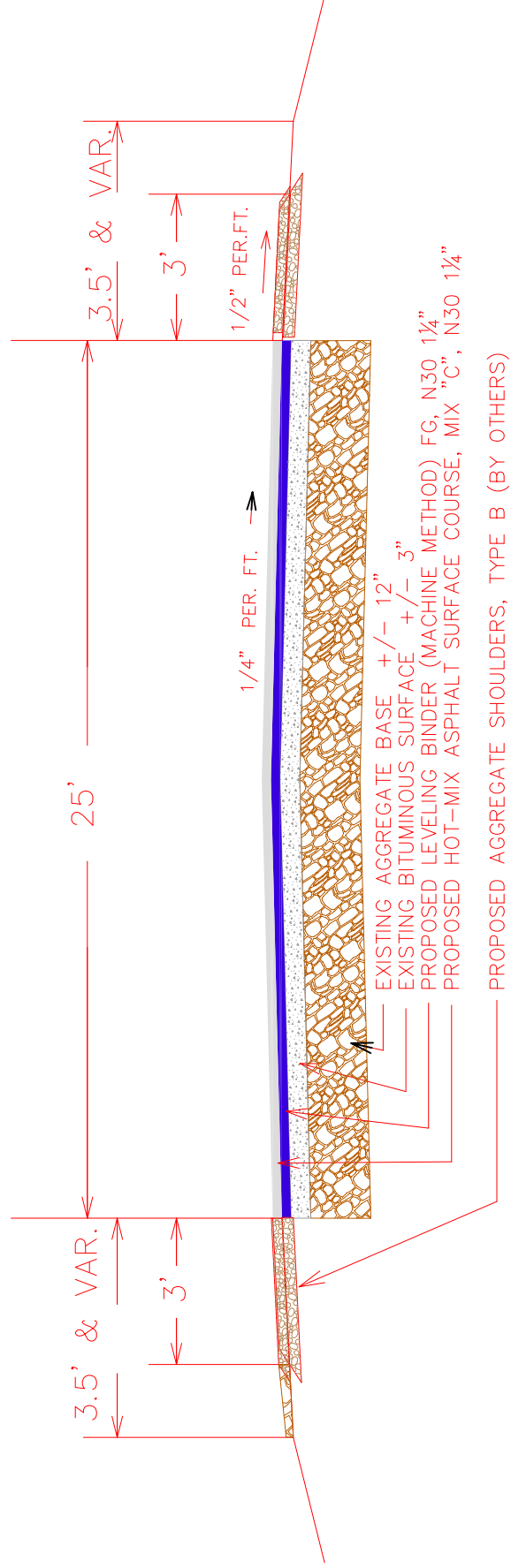

SECTION 14-18000-02-GM

TYPICAL SECTION

HUNTERS LN

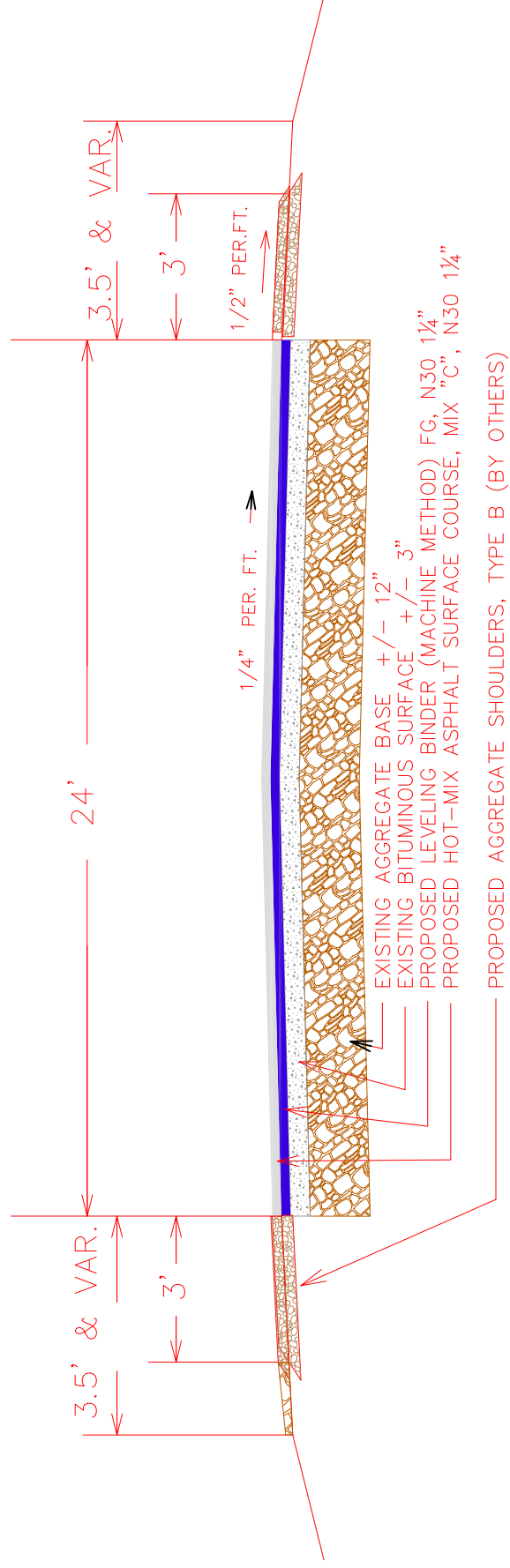

SECTION 14-18000-02-GM

TYPICAL SECTION

LUKENS ROAD

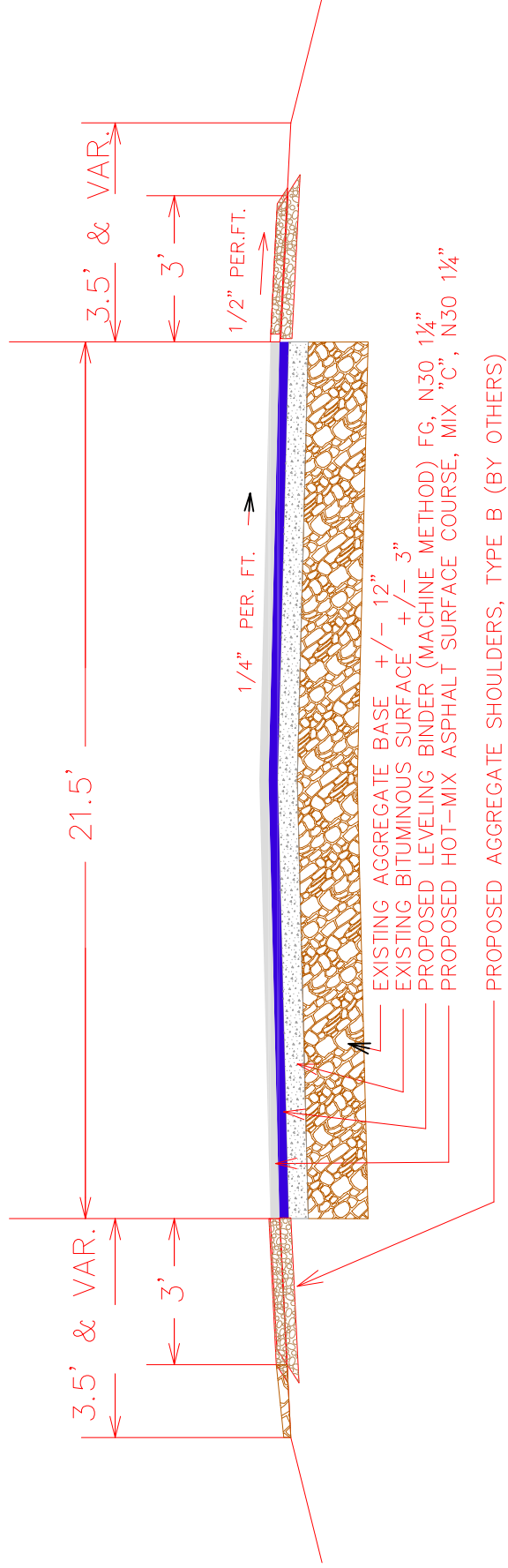

SECTION 14-18000-02-GM

OMIT STA 11+33 TO STA 12+33 (RAILROAD)

TYPICAL SECTION

NORTH GROVE RD

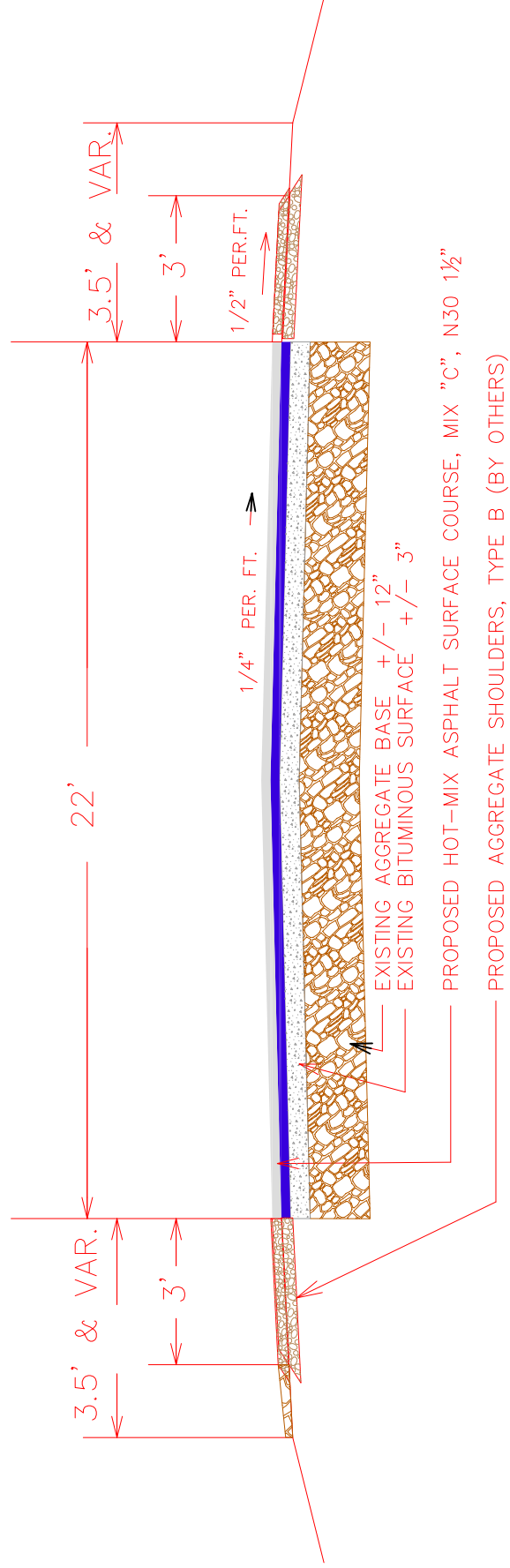

SECTION 14-18000-02-GM

TYPICAL SECTION

PRIMROSE LN

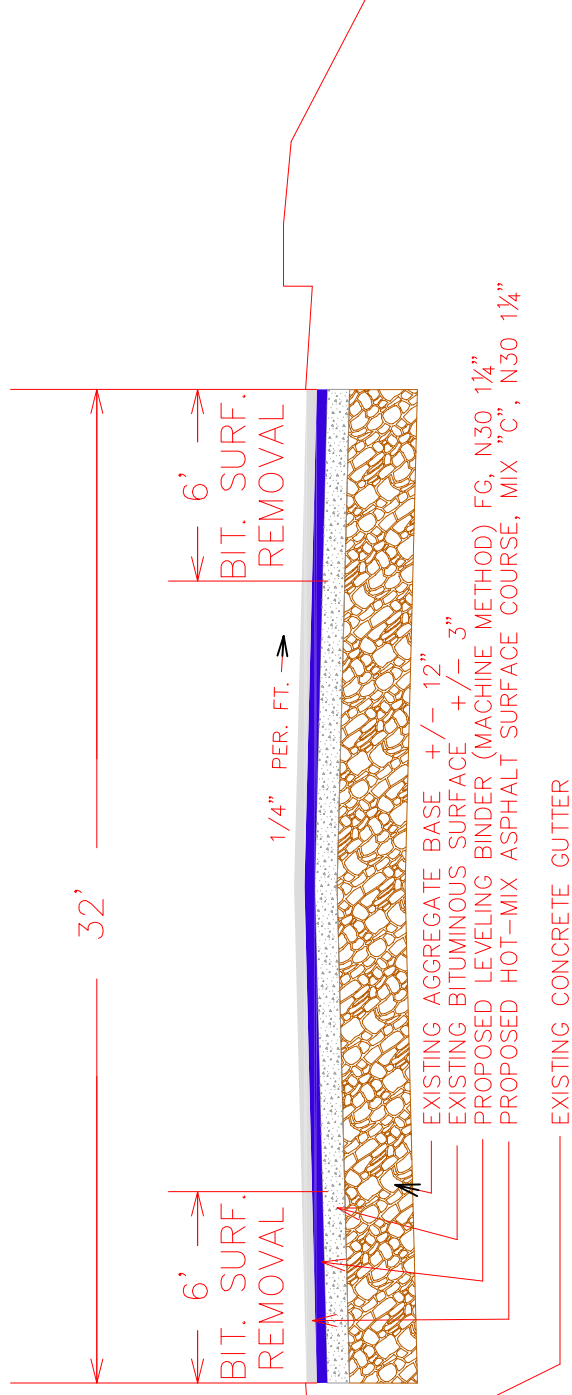

SECTION 14-18000-02-GM

ENTRANCE DETAIL

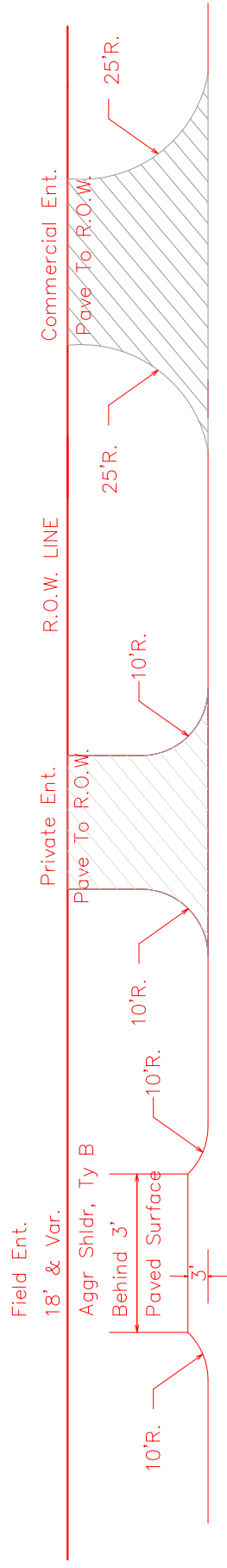

VARIOUS ROADS IN SYCAMORE TOWNSHIP

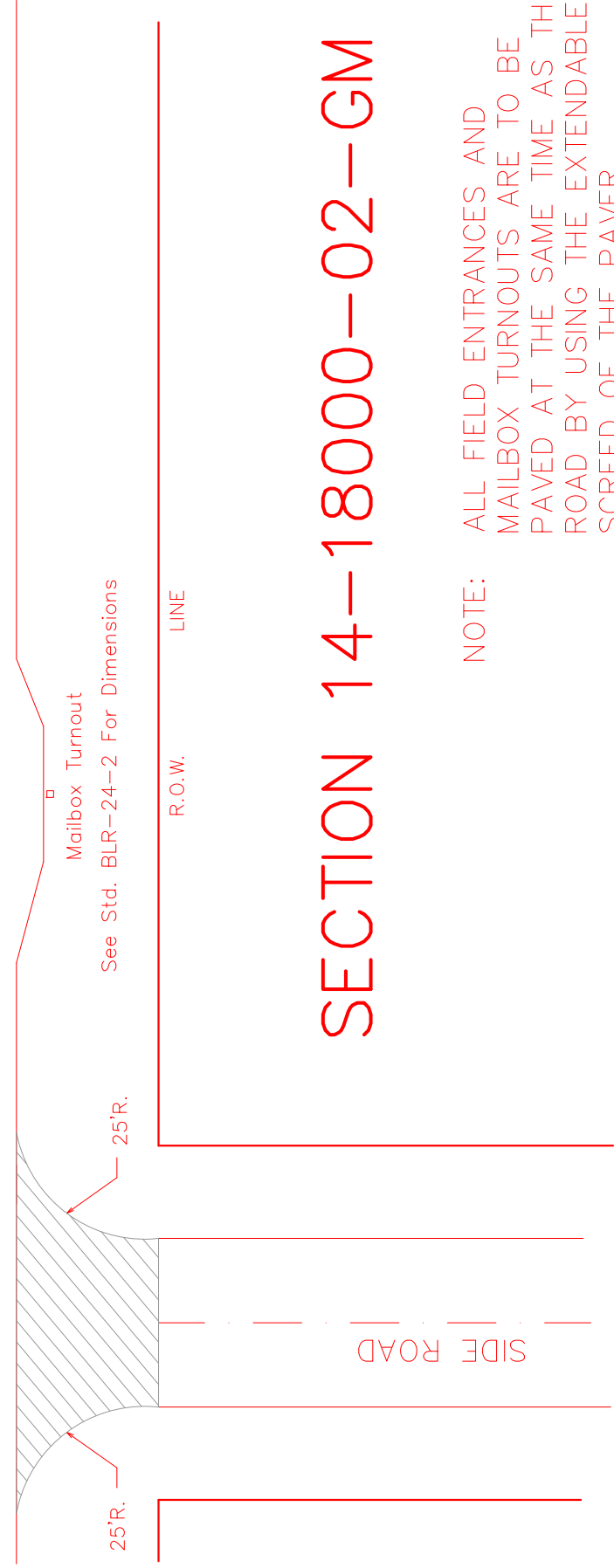

SECTION 14-18000-02-GM

NOTE: ALL FIELD ENTRANCES AND MAILBOX TURNOUTS ARE TO BE PAVED AT THE SAME TIME AS THE ROAD BY USING THE EXTENDABLE SCREED OF THE PAVER.

BUTT JOINT DETAIL

Various Roads in Sycamore Township

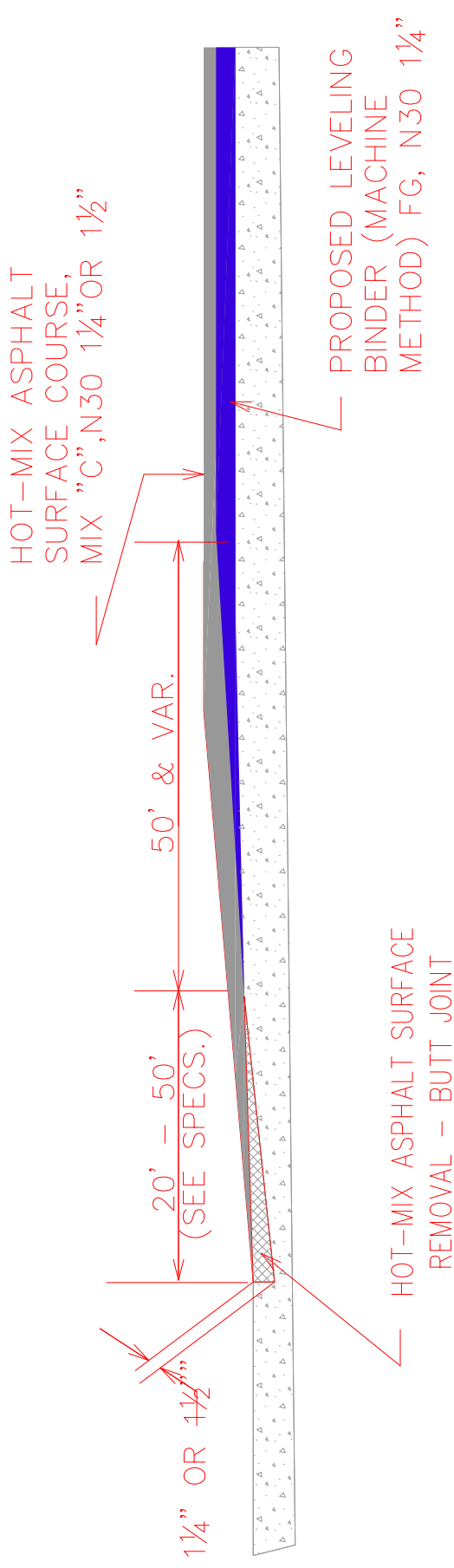

SECTION 14-18000-02-GM

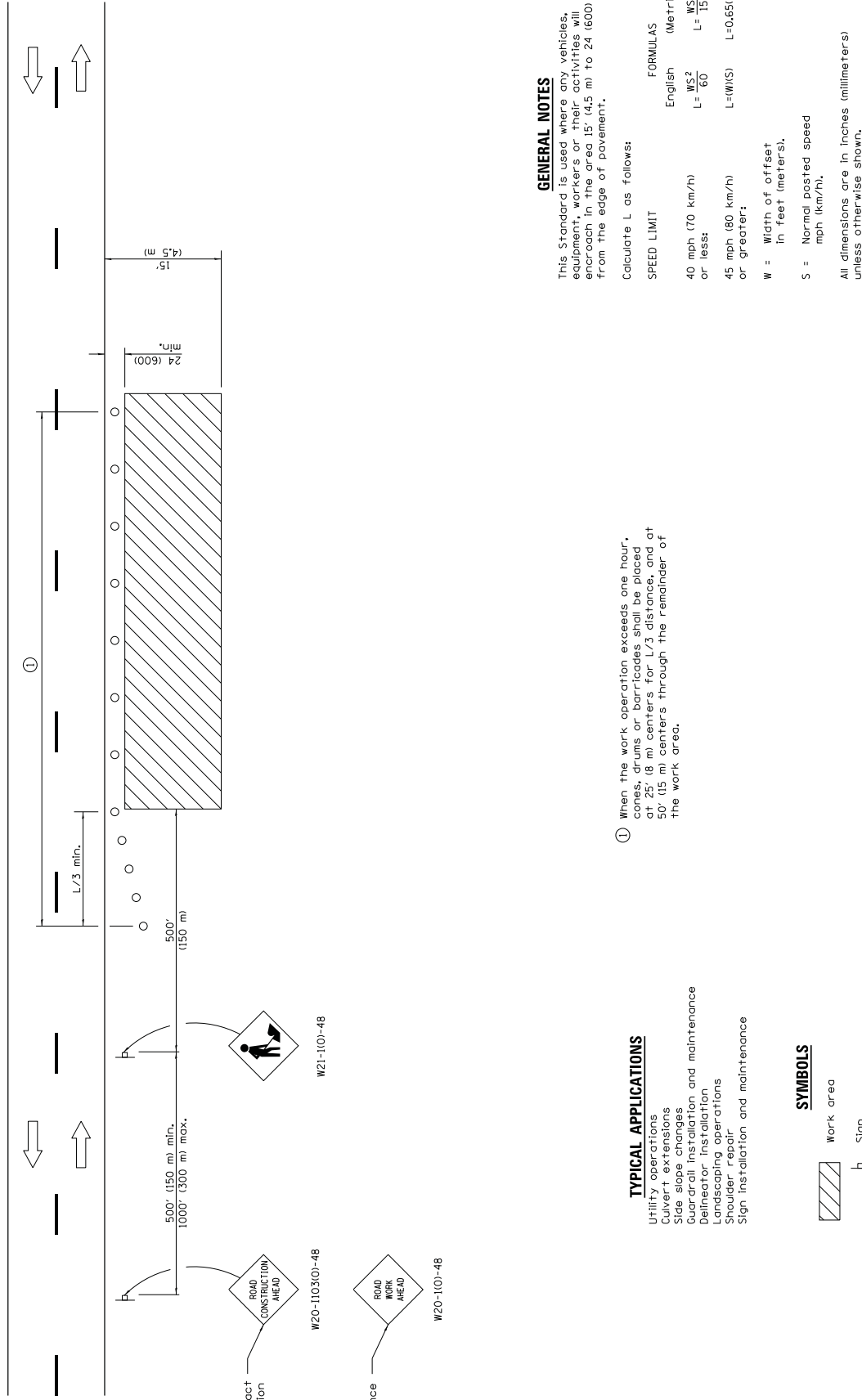

Illinois Department of Transportation
 APPROVED: [Signature] JANUARY 1, 2014
 ENGINEER OF SAFETY ENGINEERING
 APPROVED: [Signature] JANUARY 1, 2014
 ENGINEER OF DESIGN AND ENVIRONMENT

DATE	REVISIONS
1-1-14	Revised workers sign number to agree with current MUTCD.
1-1-13	Omitted text 'WORKERS' Sign.

OFF-ROAD OPERATIONS, 2L, 2W, 15' (4.5 m) TO 24" (600 mm) FROM PAVEMENT EDGE
 STANDARD 701006-05

TYPICAL APPLICATIONS

- Utility operations
- Culvert extensions
- Side slope changes
- Guardrail installation and maintenance
- Delineator installation
- Landscaping operations
- Shoulder repair
- Sign installation and maintenance

SYMBOLS

- Work area
- Sign
- Cone, drum or barricade

GENERAL NOTES

This Standard is used where any vehicles, equipment, workers or their activities will encroach in the area 15' (4.5 m) to 24' (600) from the edge of pavement.

Calculate L as follows:

SPEED LIMIT	English	Metric
40 mph (70 km/h) or less:	$L = \frac{WS^2}{60}$	$L = \frac{WS^2}{150}$
45 mph (80 km/h) or greater:	$L = (W/S)$	$L = 0.65(W/S)$

W = Width of offset in feet (meters).

S = Normal posted speed mph (km/h).

All dimensions are in inches (millimeters) unless otherwise shown.

① When the work operation exceeds one hour, cones, drums or barricades shall be placed at 25' (8 m) centers for L/3 distance, and at 50' (15 m) centers through the remainder of the work area.

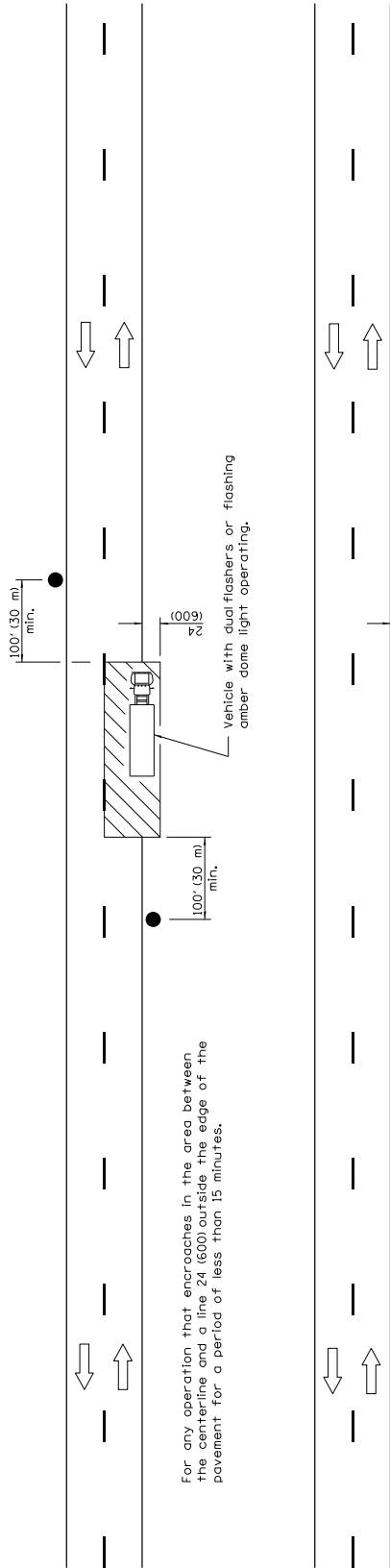

For any operation that encroaches in the area between the centerline and a line 24 (600) outside the edge of the pavement for a period of less than 15 minutes.

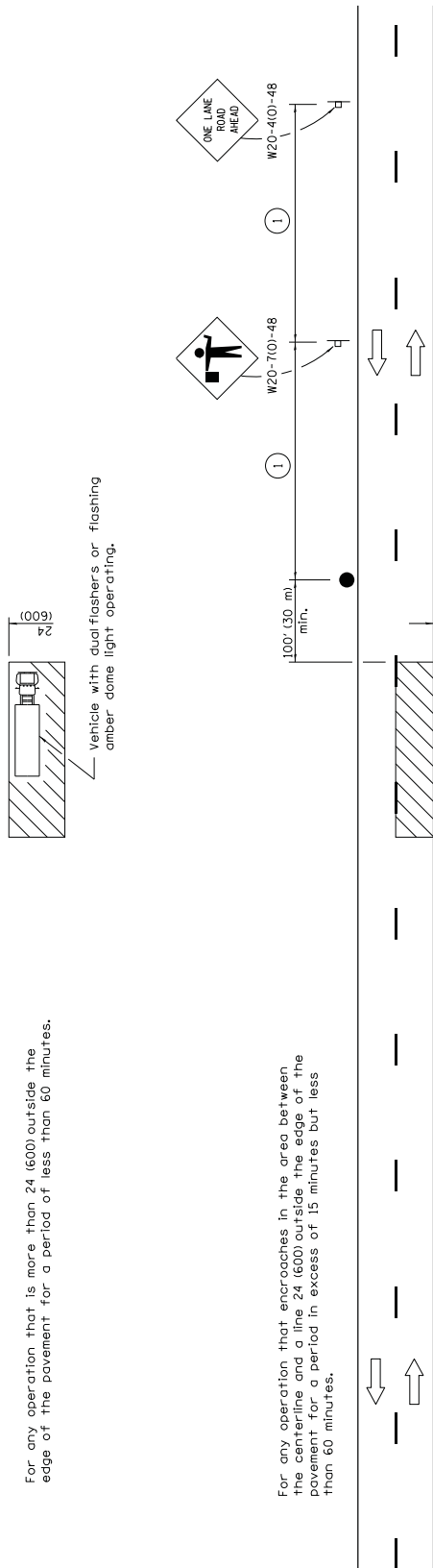

For any operation that is more than 24 (600) outside the edge of the pavement for a period of less than 60 minutes.

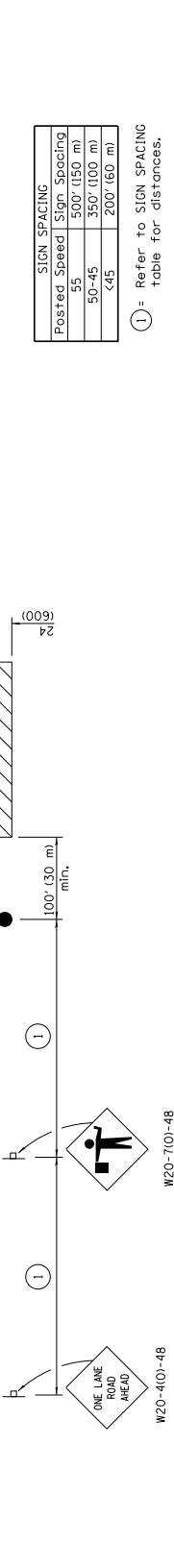

Posted Speed	Sign Spacing
55	500' (150 m)
50-45	350' (100 m)
<45	200' (60 m)

① - Refer to SIGN SPACING table for distances.

All dimensions are in inches (millimeters) unless otherwise shown.

DATE	REVISIONS
1-1-11	Revised flagger sign.
1-1-09	Switched units to English metric.

LANE CLOSURE, 2L, 2W, SHORT TIME OPERATIONS

STANDARD 701301-04

SYMBOLS

- Work area
- Sign on portable or permanent support
- Flagger with traffic control sign

TYPICAL APPLICATIONS

- Marking patches
- Field survey
- String line
- Utility operations
- Cleaning up debris on pavement

Illinois Department of Transportation
 APPROVED *[Signature]* JANUARY 2011
 ENGINEER OF SAFETY ENGINEERING
 APPROVED *[Signature]* JANUARY 2011
 ENGINEER OF DESIGN AND ENVIRONMENT

ISSUED 1-1-97

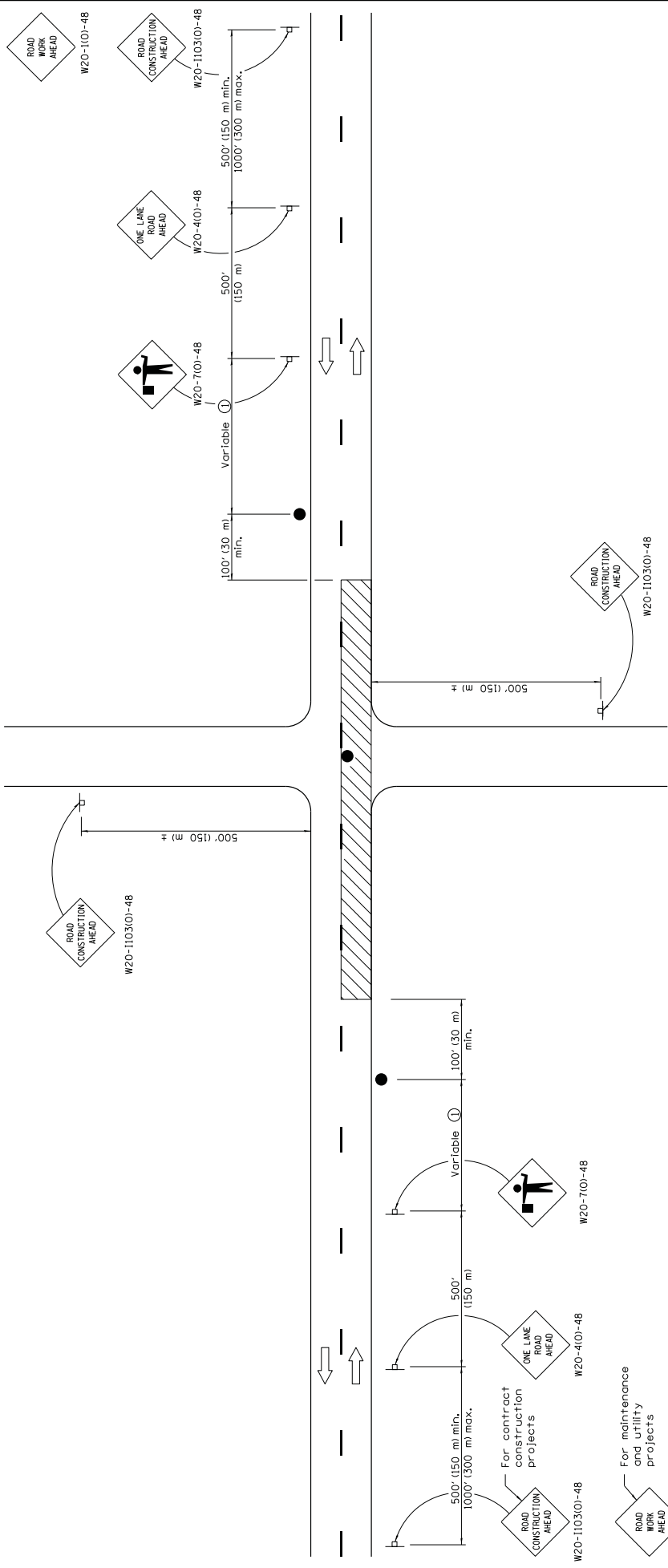

GENERAL NOTES



This Standard is used where at any time, any vehicle, equipment, workers or their activities require an intermittent or continuous moving operation on the pavement where the average speed of movement is greater than 1 mph (2 km/h) and less than 4 mph (6 km/h).

When the operation does not exceed 60 minutes, traffic control may be according to Standard 701301.

All dimensions are in inches (millimeters) unless otherwise shown.

① Minimum distance is 200' (60 m). Maximum distance to be determined by the Engineer but should not exceed 1/2 the length required for one normal working day's operation or 2 miles (3200 m), whichever is less.

SYMBOLS

-  Work area
-  Sign on portable or permanent support
-  Flagger with traffic control sign

TYPICAL APPLICATIONS

- Bituminous resurfacing
- Milling operations
- Utility operations
- Shoulder operations

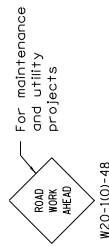

DATE	REVISIONS
1-1-11	Revised flagger sign.
1-1-09	Switched units to English metric.
	Corrected sign No.'s.

LANE CLOSURE, 2L, 2W, SLOW MOVING OPERATIONS DAY ONLY, FOR SPEEDS > 45 MPH

STANDARD 701306-03

Illinois Department of Transportation

APPROVED *[Signature]* JANUARY 2011

ENGINEER OF SAFETY ENGINEERING

APPROVED *[Signature]* JANUARY 1, 2011

ENGINEER OF DESIGN AND ENVIRONMENT

ISSUED 1-1-97

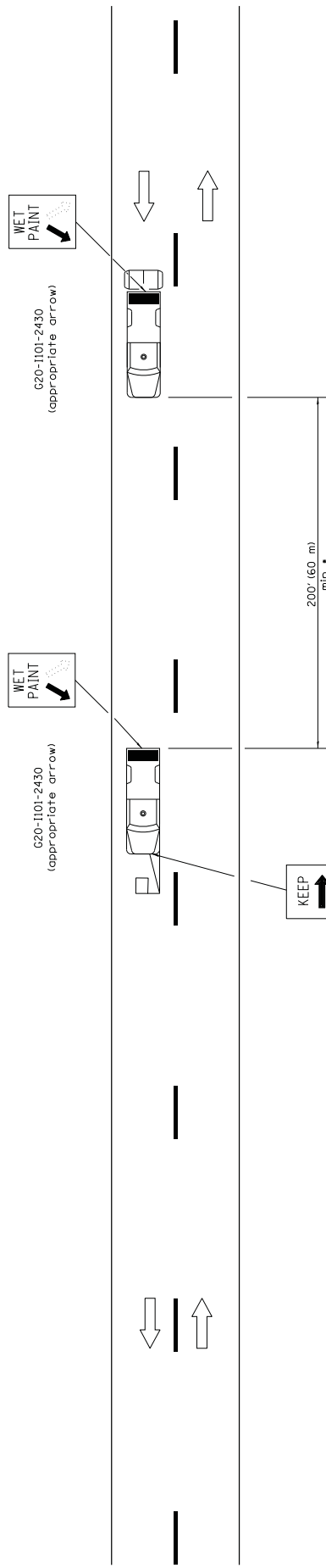

• Distance varies depending on terrain and susceptibility of pavement marking or crack sealant to wheel tracking.

TYPICAL APPLICATIONS

- Landscaping work
- Utility work
- Pavement marking
- Seed spraying
- Radometer measurements
- Debris cleanup
- Crack pouring

SYMBOLS

- Arrow board (Hazard Mode only)
- Truck with headlights, emergency flashers, and flashing amber light. (Visible from all directions)
- 18x18 (450x450) min. orange flag (use when guide wheels used)
- Truck mounted attenuator

GENERAL NOTES

This Standard is used where any vehicle, equipment, workers or their activities will require a continuous moving operation where the average speed is greater than 3 mph (5 km/h).

For shoulder operations not encroaching on the pavement, use DETAIL A, Standard 701426. All dimensions are in inches (millimeters) unless otherwise shown.

Illinois Department of Transportation APPROVED ENGINEER OF OPERATIONS APPROVED ENGINEER OF DESIGN AND ENVIRONMENT	JANUARY 1, 2009 <i>[Signature]</i>	ISSUED 1-1-97
	JANUARY 1, 2009 <i>[Signature]</i>	

DATE	REVISIONS
1-1-09	Switched units to English (metric). Omitted Pass With Care sign.
1-1-00	Elim. speed restrictions in Standard title.

**LANE CLOSURE 2L, 2W
MOVING OPERATIONS—
DAY ONLY**

STANDARD 701311-03

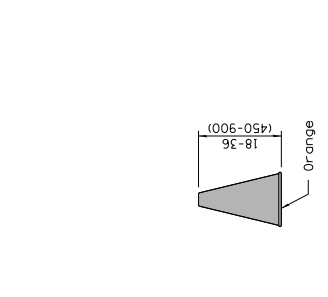
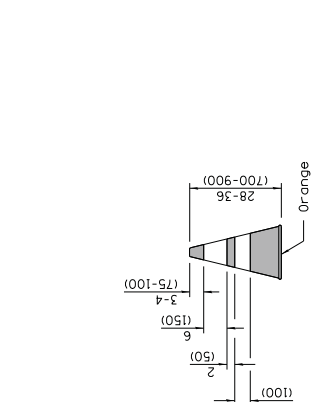
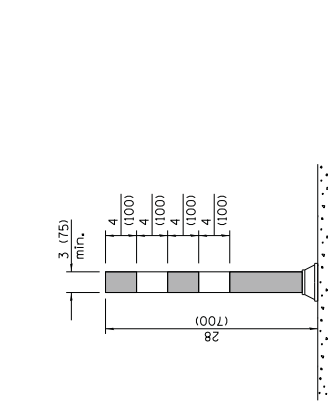
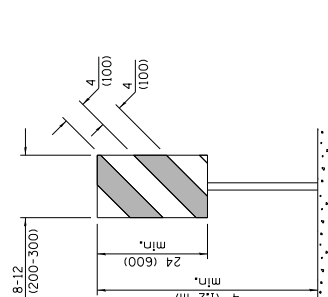
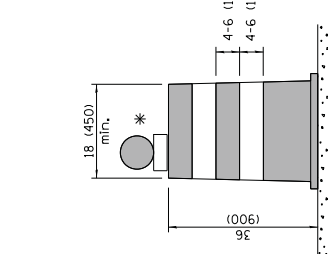

CONE

REFLECTORIZED CONE

FLEXIBLE DELINEATOR

VERTICAL PANEL POST MOUNTED

DRUM

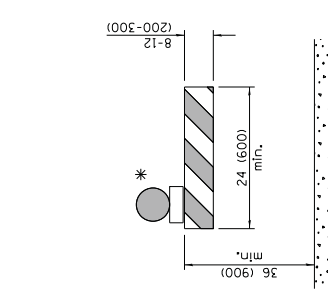
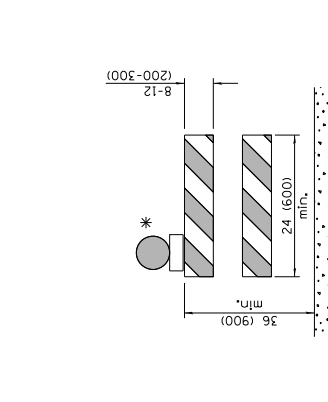
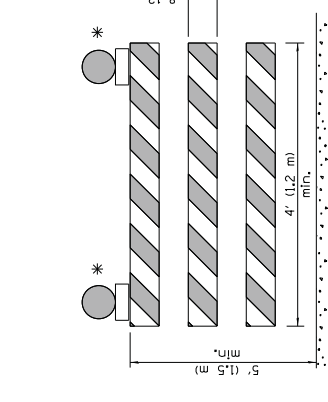
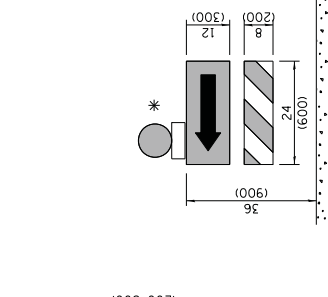
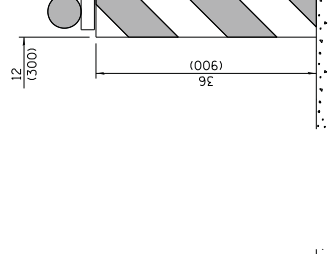

TYPE I BARRICADE

TYPE II BARRICADE

TYPE III BARRICADE

DIRECTION INDICATOR BARRICADE

VERTICAL BARRICADE

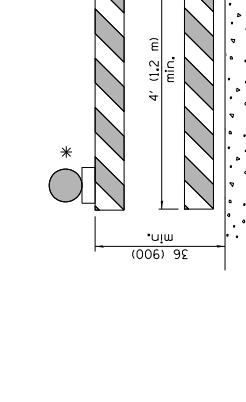
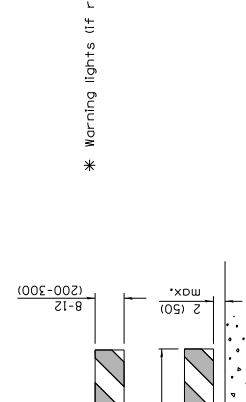
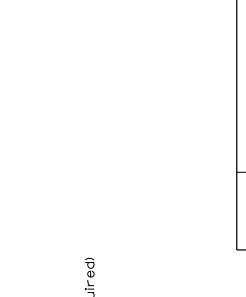
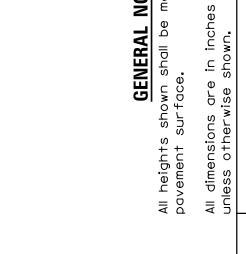

DETECTABLE PEDESTRIAN CHANNELIZING BARRICADE

DETECTABLE PEDESTRIAN CHANNELIZING BARRICADE

DETECTABLE PEDESTRIAN CHANNELIZING BARRICADE

DETECTABLE PEDESTRIAN CHANNELIZING BARRICADE

DETECTABLE PEDESTRIAN CHANNELIZING BARRICADE

* Warning lights (if required)

GENERAL NOTES
All heights shown shall be measured above the pavement surface.
All dimensions are in inches (millimeters) unless otherwise shown.

DATE	REVISIONS
1-1-14	Modified flogger sign height.
	Added highway construction speed zone signs.
1-1-12	Added DETECTABLE PEDESTRIAN CHANNELIZING BARRICADE.

TRAFFIC CONTROL DEVICES
STANDARD 701901-03
(Sheet 1 of 3)

Illinois Department of Transportation
APPROVED: [Signature] JANUARY 1, 2014
ENGINEER OF OPERATIONS
APPROVED: [Signature] JANUARY 1, 2014
ENGINEER OF DESIGN AND ENVIRONMENT
ISSUED 1-1-97

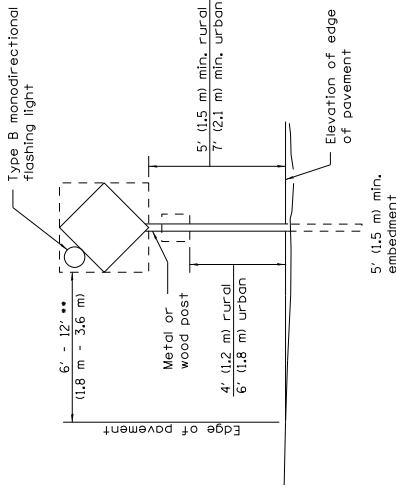

POST MOUNTED SIGNS

.. When curb or paved shoulder are present this dimension shall be 24 (600) to the face of curb or 6' (1.8 m) to the outside edge of the paved shoulder.

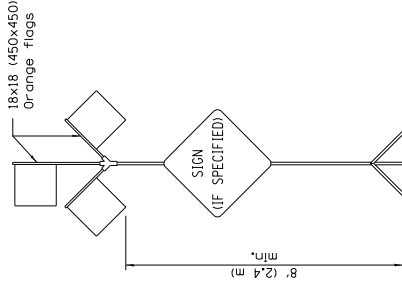

HIGH LEVEL WARNING DEVICE

... When work operations exceed four days, this dimension shall be 5' (1.5 m) min. If located behind other devices, the height shall be sufficient to be seen completely above the devices.

SIGNS ON TEMPORARY SUPPORTS

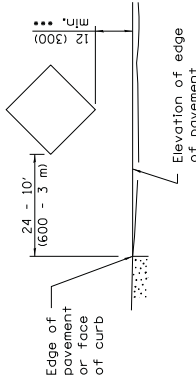

ROAD CONSTRUCTION NEXT X MILES
G20-1101-6036

END CONSTRUCTION
G20-2a(0)-6024

This signing is required for all projects 2 miles (3200 m) or more in length.

ROAD CONSTRUCTION NEXT X MILES sign shall be placed 500' (150 m) in advance of project limits.

END CONSTRUCTION sign shall be erected at the end of the job unless another job is within 2 miles (3200 m).

Dual sign displays shall be utilized on multi-lane highways.

WORK LIMIT SIGNING

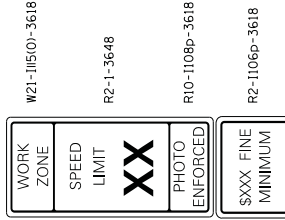

Sign assembly as shown on Standards or as allowed by District Operations.

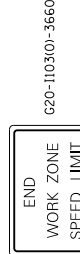

This sign shall be used when the above sign assembly is used.

HIGHWAY CONSTRUCTION SPEED ZONE SIGNS

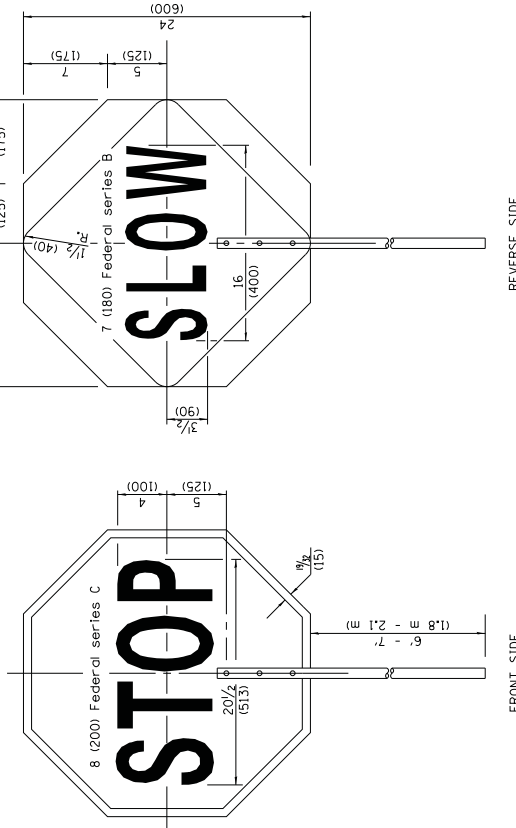

FLAGGER TRAFFIC CONTROL SIGN

REVERSE SIDE

FRONT SIDE

Illinois Department of Transportation

APPROVED: [Signature] JANUARY 1, 2014
ENGINEER OF OPERATIONS

APPROVED: [Signature] JANUARY 1, 2014
ENGINEER OF DESIGN AND ENVIRONMENT

ISSUED 1-1-97

TRAFFIC CONTROL DEVICES

(Sheet 2 of 3)

STANDARD 701901-03

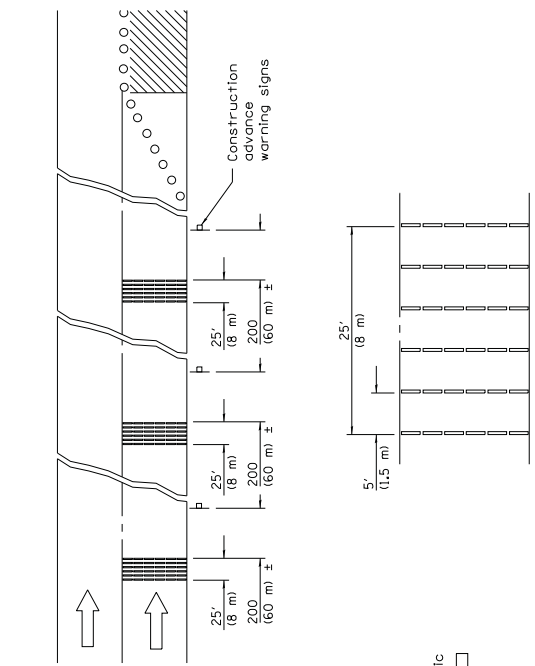

TYPICAL INSTALLATION

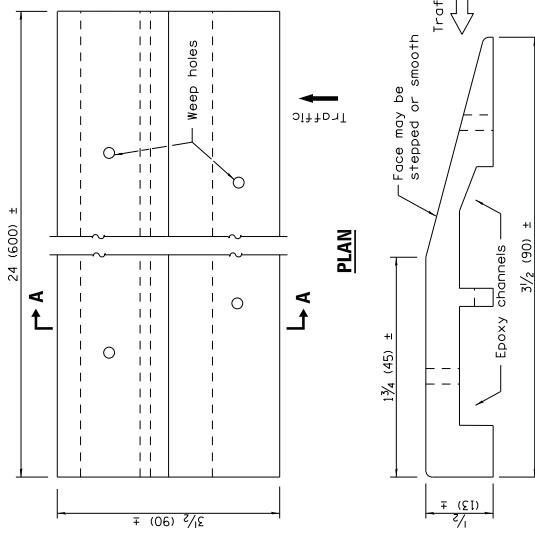

SECTION A-A

TEMPORARY RUMBLE STRIPS

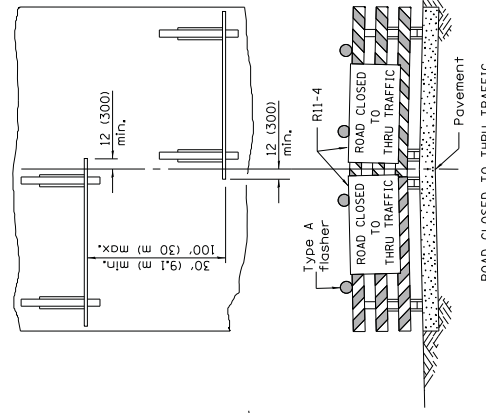

ROAD CLOSED TO THRU TRAFFIC

ReflectORIZED striping shall appear on both sides of the barricades. If a Type III barricade with an attached sign panel which meets NCHRP 350 is not available, the signs may be mounted on NCHRP 350 temporary sign supports directly in front of the barricade.

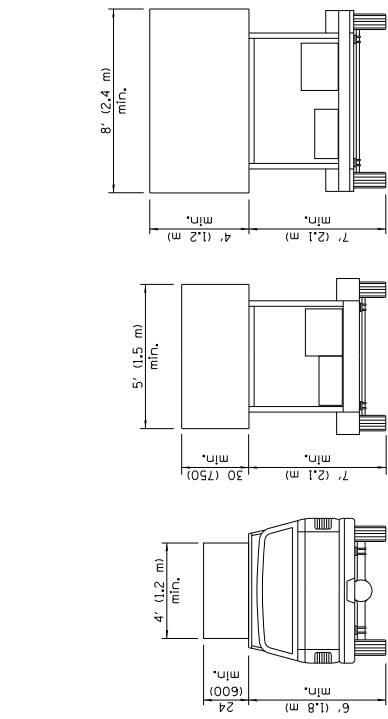

**TYPE C
TRAILER
MOUNTED**

**TYPE B
ROOF OR TRAILER
MOUNTED**

**TYPE A
ROOF
MOUNTED**

ARROW BOARDS

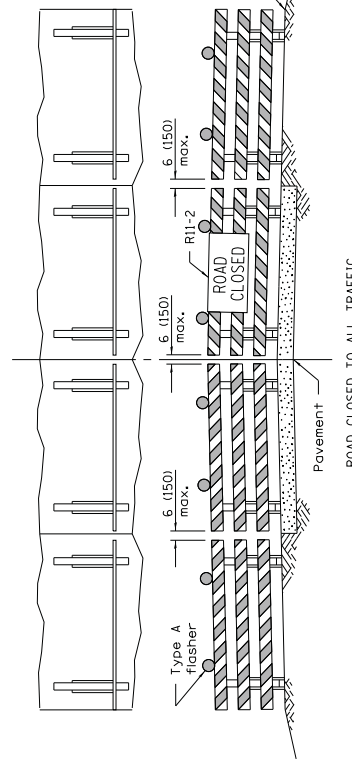

ROAD CLOSED TO ALL TRAFFIC

ReflectORIZED striping may be omitted on the back side of the barricades. If a Type III barricade with an attached sign panel which meets NCHRP 350 is not available, the sign may be mounted on an NCHRP 350 temporary sign support directly in front of the barricade.

**TYPICAL APPLICATIONS OF
TYPE III BARRICADES CLOSING A ROAD**

Illinois Department of Transportation APPROVED: <i>[Signature]</i> JANEY, L. 2014 ENGINEER OF OPERATIONS APPROVED: <i>[Signature]</i> JANEY, L. 2014 ENGINEER OF DESIGN AND ENVIRONMENT	ISSUED 1-1-97
---	---------------

**TRAFFIC CONTROL
DEVICES**

(Sheet 3 of 3)

STANDARD 701901-03

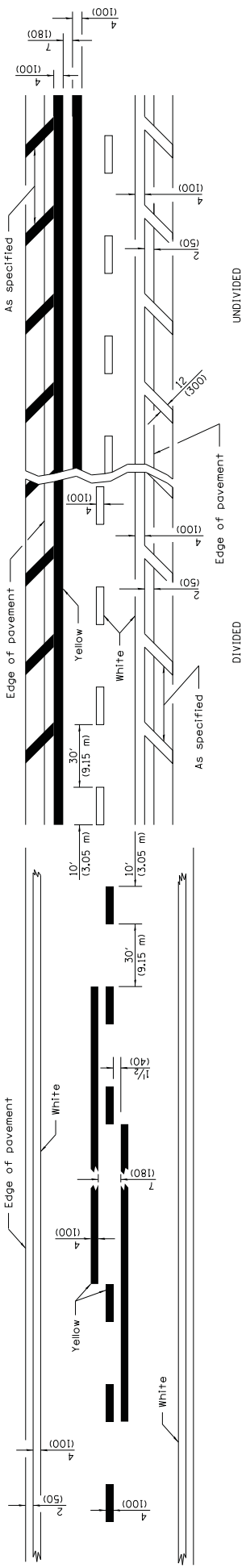

2 LANE
DIVIDED
MULTI LANE
UNDIVIDED

LANE AND EDGE LINES

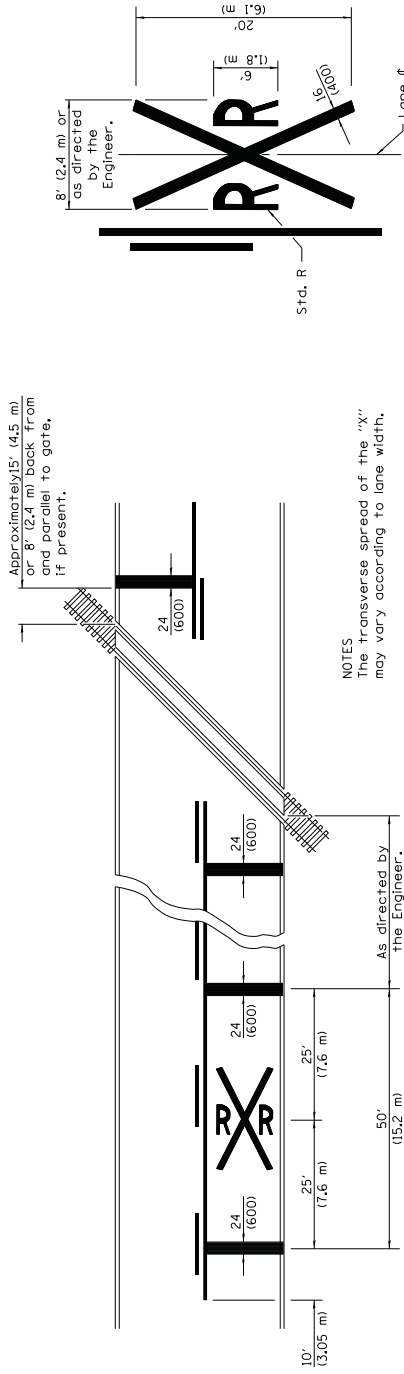

NOTES
The transverse spread of the "X" may vary according to lane width. On multi-lane roads, the stop lines shall extend across all approach lanes and separate RR symbols shall be placed adjacent to each other in each lane. When the pavement marking symbol is used, a portion of the symbol should be located directly adjacent to the Advance Warning Sign (M10-1) as placed by Table 2C-4, Condition B of the MUTCD.

PAVEMENT MARKINGS AT RAILROAD-HIGHWAY GRADE CROSSING

DATE	REVISIONS
1-1-14	Added bike symbol. Renamed 'LANE DROP ARROW' detail to 'LANE-REDUCTION ARROW'.
1-1-12	Updated reference to current MUTCD table in notes.

All dimensions are in inches (millimeters) unless otherwise shown.

Illinois Department of Transportation APPROVED: <i>[Signature]</i> January 1, 2014 ENGINEER OF OPERATIONS APPROVED: <i>[Signature]</i> January 1, 2014 ENGINEER OF DESIGN AND ENVIRONMENT	ISSUED 1-1-97
---	---------------

TYPICAL PAVEMENT MARKINGS

STANDARD 780001-04
(Sheet 1 of 2)

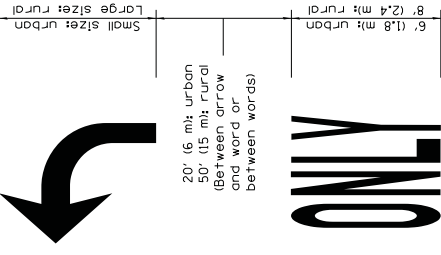
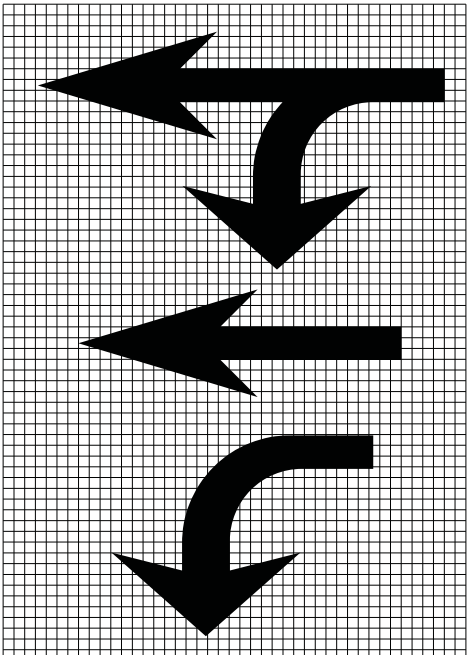
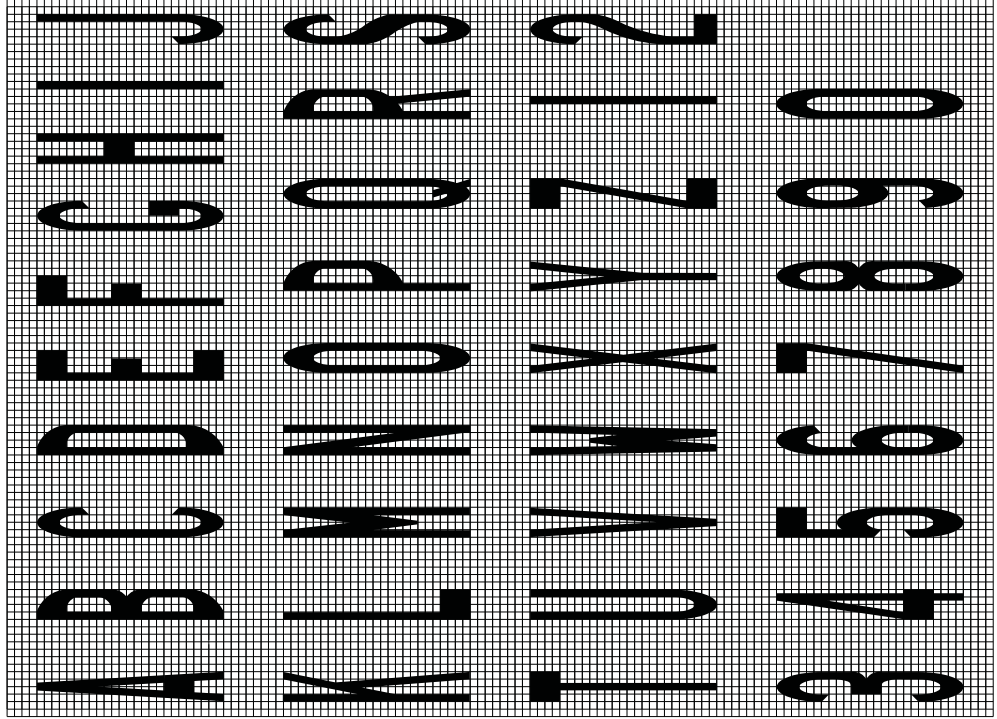

WORD AND ARROW LAYOUT

Legend Height	Arrow Size	o
6' (1.8 m)	Small	2.9 (74)
8' (2.4 m)	Large	3.8 (96)

The space between adjacent letters or numerals should be approximately 3 (75) for 6' (1.8 m) legend and 4 (100) for 8' (2.4 m) legend.

LETTER AND ARROW GRID SCALE

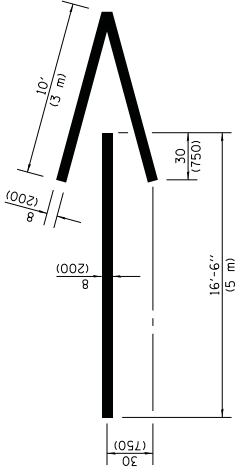

WRONG WAY ARROW

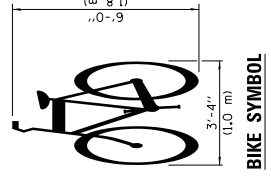

BIKE SYMBOL

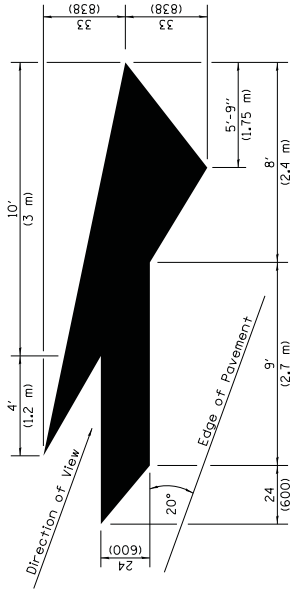

LANE-REDUCTION ARROW

Right lane-reduction arrow shown. Use mirror image for left lane.

TYPICAL PAVEMENT MARKINGS

(Sheet 2 of 2)

STANDARD 780001-04

Illinois Department of Transportation

ISSUED 1-1-97

APPROVED January 1, 2014
 Walter J. Mann
 ENGINEER OF OPERATIONS

APPROVED January 1, 2014

 ENGINEER OF DESIGN AND ENVIRONMENT

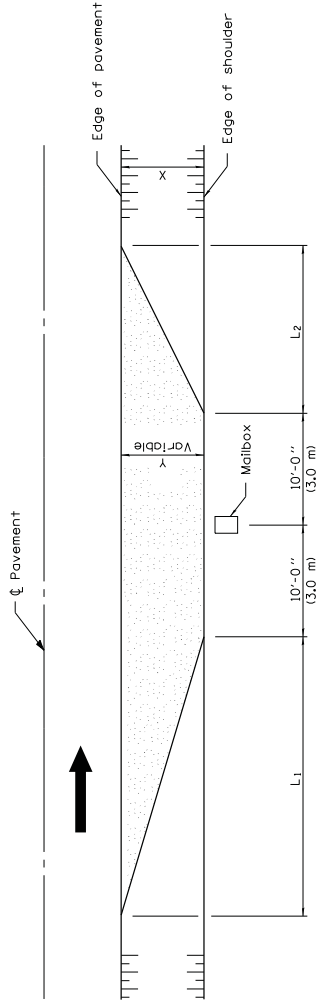

TYPICAL APPLICATION

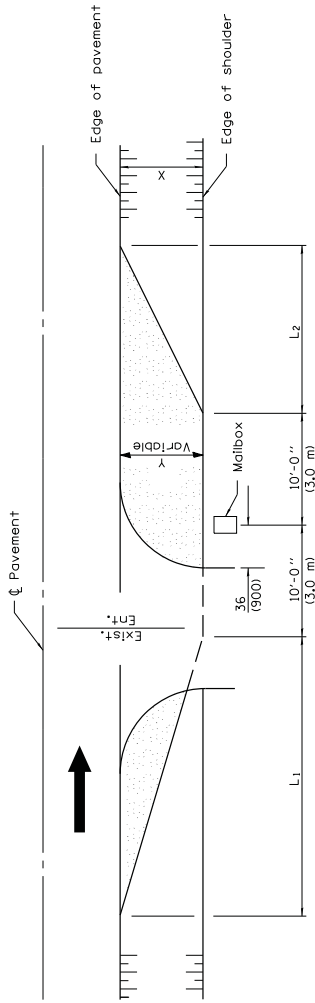

MAILBOX ON FAR SIDE OF ENTRANCE

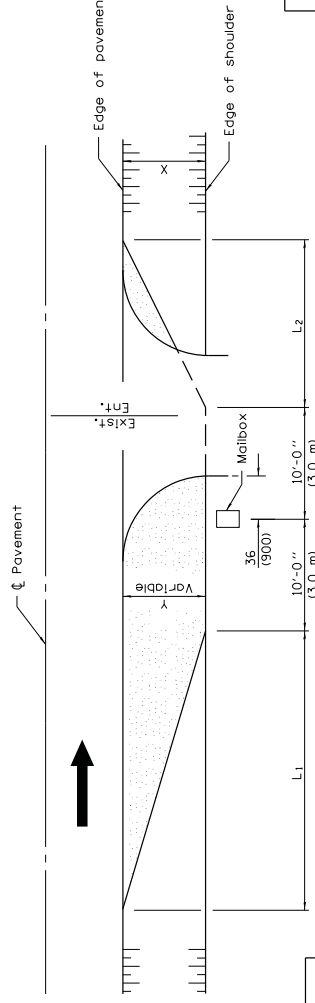

MAILBOX ON NEAR SIDE OF ENTRANCE

DIMENSIONS - ft. (m)									
Width of Shoulder (X)	12 (3.6)	10 (3.0)	8 (2.4)	6 (1.8)	5 (1.5)	4 (1.2)			
Width of Turnout (Y)	8 (2.4)	8 (2.4)	6 (1.8)	4 (1.2)	4 (1.2)	4 (1.2)			
L ₁	30 (9.0)	30 (9.0)	23 (6.9)	15 (4.5)	15 (4.5)	15 (4.5)			
L ₂	20 (6.0)	20 (6.0)	15 (4.5)	10 (3.0)	10 (3.0)	10 (3.0)			

Note:
Dimensions for Township and District Roads may vary from the above dimensions.

GENERAL NOTES

Mailboxes shall be mounted such that the face of the mailbox is 6 (150) to 12 (300) and the post a minimum of 24 (600) from the edge of the turnout surfacing.

All dimensions are in inches (millimeters) unless otherwise shown.

DATE	REVISIONS
1-1-09	Switched units to English (metric).
1-1-99	Add width of shoulder X.

MAILBOX TURNOUT FOR LOCAL ROADS

STANDARD B.L.R. 24-2

Illinois Department of Transportation

APPROVED JANUARY 1, 2009

Charles J. Pappas
ENGINEER OF LOCAL ROADS AND STREETS

APPROVED JANUARY 1, 2009

Lee S. Ho
ENGINEER OF DESIGN AND ENVIRONMENT

ISSUED 1-1-97

INDEX
FOR
SUPPLEMENTAL SPECIFICATIONS
AND RECURRING SPECIAL PROVISIONS

Adopted January 1, 2014

This index contains a listing of SUPPLEMENTAL SPECIFICATIONS, frequently used RECURRING SPECIAL PROVISIONS, and LOCAL ROADS AND STREETS RECURRING SPECIAL PROVISIONS.

ERRATA Standard Specifications for Road and Bridge Construction (Adopted 1-1-12) (Revised 1-1-14)

SUPPLEMENTAL SPECIFICATIONS

<u>Std. Spec. Sec.</u>	<u>Page No.</u>
101 Definition of Terms	1
102 Advertisement, Bidding, Award, and Contract Execution	2
105 Control of Work	3
106 Control of Materials	5
107 Legal Regulations and Responsibility to Public	6
108 Prosecution and Progress	14
109 Measurement and Payment	15
202 Earth and Rock Excavation	17
211 Topsoil and Compost	18
253 Planting Woody Plants	19
280 Temporary Erosion and Sediment Control	21
312 Stabilized Subbase	22
406 Hot-Mix Asphalt Binder and Surface Course	23
407 Hot-Mix Asphalt Pavement (Full-Depth)	26
420 Portland Cement Concrete Pavement	30
424 Portland Cement Concrete Sidewalk	32
440 Removal of Existing Pavement and Appurtenances	33
503 Concrete Structures	34
504 Precast Concrete Structures	37
506 Cleaning and Painting New Steel Structures	38
512 Piling	39
516 Drilled Shafts	40
521 Bearings	41
540 Box Culverts	42
588 Bridge Relief Joint System	43
589 Elastic Joint Sealer	45
602 Catch Basin, Manhole, Inlet, Drainage Structure, and Valve Vault Construction, Adjustment, and Reconstruction	46
603 Adjusting Frames and Grates of Drainage and Utility Structures	47
606 Concrete Gutter, Curb, Median, and Paved Ditch	49
610 Shoulder Inlets with Curb	50
639 Precast Prestressed Concrete Sight Screen	51
642 Shoulder Rumble Strips	52
643 Impact Attenuators	53
644 High Tension Cable Median Barrier	55
701 Work Zone Traffic Control and Protection	57
706 Impact Attenuators, Temporary	60
707 Movable Traffic Barrier	63
708 Temporary Water Filled Barrier	65
730 Wood Sign Support	67
780 Pavement Striping	68
860 Master Controller	73
1001 Cement	74
1003 Fine Aggregates	75
1004 Coarse Aggregates	77
1006 Metals	81
1011 Mineral Filler	83

1017	Packaged, Dry, Combined Materials for Mortar	84
1018	Packaged Rapid Hardening Mortar or Concrete	85
1019	Controlled Low-Strength Material	86
1020	Portland Cement Concrete	87
1024	Grout and Nonshrink Grout	126
1030	Hot-Mix Asphalt	127
1040	Drain Pipe, Tile, Drainage Mat, and Wall Drain	132
1042	Precast Concrete Products	133
1070	Foundation and Breakaway Devices	134
1073	Controller	135
1081	Materials for Planting	136
1082	Prefomed Bearing Pads	137
1083	Elastomeric Bearings	138
1095	Pavement Markings	139
1101	General Equipment	142
1102	Hot-Mix Asphalt Equipment	144
1105	Pavement Marking Equipment	146
1106	Work Zone Traffic Control Devices	147

CHECK SHEET
FOR
RECURRING SPECIAL PROVISIONS

Adopted January 1, 2014

The following RECURRING SPECIAL PROVISIONS indicated by an "X" are applicable to this contract and are included by reference:

<u>CHECK SHEET #</u>	<u>RECURRING SPECIAL PROVISIONS</u>	<u>PAGE NO.</u>
1	<input type="checkbox"/> Additional State Requirements for Federal-Aid Construction Contracts (Eff. 2-1-69)(Rev. 1-1-10)	149
2	<input type="checkbox"/> Subletting of Contracts (Federal-Aid Contracts) (Eff. 1-1-88) (Rev. 5-1-93)	152
3	<input type="checkbox"/> EEO (Eff. 7-21-78) (Rev. 11-18-80)	153
4	<input type="checkbox"/> Specific Equal Employment Opportunity Responsibilities Non Federal-Aid Contracts (Eff. 3-20-69) (Rev. 1-1-94)	163
5	<input type="checkbox"/> Required Provisions - State Contracts (Eff. 4-1-65) (Rev. 1-1-13)	168
6	<input type="checkbox"/> Asbestos Bearing Pad Removal (Eff. 11-1-03)	173
7	<input type="checkbox"/> Asbestos Waterproofing Membrane and Asbestos Hot-Mix Asphalt Surface Removal (Eff. 6-1-89) (Rev. 1-1-09)	174
8	<input type="checkbox"/> Haul Road Stream Crossings, Other Temporary Stream Crossings, and In-Stream Work Pads (Eff. 1-2-92) (Rev. 1-1-98)	175
9	<input type="checkbox"/> Construction Layout Stakes Except for Bridges (Eff. 1-1-99) (Rev. 1-1-07)	176
10	<input type="checkbox"/> Construction Layout Stakes (Eff. 5-1-93) (Rev. 1-1-07)	179
11	<input type="checkbox"/> Use of Geotextile Fabric for Railroad Crossing (Eff. 1-1-95) (Rev. 1-1-07)	182
12	<input type="checkbox"/> Subsealing of Concrete Pavements (Eff. 11-1-84) (Rev. 1-1-07)	184
13	<input type="checkbox"/> Hot-Mix Asphalt Surface Correction (Eff. 11-1-87) (Rev. 1-1-09)	188
14	<input type="checkbox"/> Pavement and Shoulder Resurfacing (Eff. 2-1-00) (Rev. 1-1-09)	190
15	<input type="checkbox"/> PCC Partial Depth Hot-Mix Asphalt Patching (Eff. 1-1-98) (Rev. 1-1-07)	191
16	<input type="checkbox"/> Patching with Hot-Mix Asphalt Overlay Removal (Eff. 10-1-95) (Rev. 1-1-07)	193
17	<input type="checkbox"/> Polymer Concrete (Eff. 8-1-95) (Rev. 1-1-08)	194
18	<input type="checkbox"/> PVC Pipeliner (Eff. 4-1-04) (Rev. 1-1-07)	196
19	<input type="checkbox"/> Pipe Underdrains (Eff. 9-9-87) (Rev. 1-1-07)	197
20	<input type="checkbox"/> Guardrail and Barrier Wall Delineation (Eff. 12-15-93) (Rev. 1-1-12)	198
21	<input type="checkbox"/> Bicycle Racks (Eff. 4-1-94) (Rev. 1-1-12)	202
22	<input type="checkbox"/> Temporary Modular Glare Screen System (Eff. 1-1-00) (Rev. 1-1-07)	204
23	<input type="checkbox"/> Temporary Portable Bridge Traffic Signals (Eff. 8-1-03) (Rev. 1-1-07)	206
24	<input type="checkbox"/> Work Zone Public Information Signs (Eff. 9-1-02) (Rev. 1-1-07)	208
25	<input type="checkbox"/> Night Time Inspection of Roadway Lighting (Eff. 5-1-96)	209
26	<input type="checkbox"/> English Substitution of Metric Bolts (Eff. 7-1-96)	210
27	<input type="checkbox"/> English Substitution of Metric Reinforcement Bars (Eff. 4-1-96) (Rev. 1-1-03)	211
28	<input type="checkbox"/> Calcium Chloride Accelerator for Portland Cement Concrete (Eff. 1-1-01) (Rev. 1-1-13)	212
29	<input type="checkbox"/> Portland Cement Concrete Inlay or Overlay for Pavements (Eff. 11-1-08) (Rev. 1-1-13)	213
30	<input type="checkbox"/> Quality Control of Concrete Mixtures at the Plant (Eff. 8-1-00) (Rev. 1-1-14)	216
31	<input type="checkbox"/> Quality Control/Quality Assurance of Concrete Mixtures (Eff. 4-1-92) (Rev. 1-1-14)	224
32	<input type="checkbox"/> Digital Terrain Modeling for Earthwork Calculations (Eff. 4-1-07)	240
33	<input type="checkbox"/> Pavement Marking Removal (Eff. 4-1-09)	242
34	<input type="checkbox"/> Preventive Maintenance – Bituminous Surface Treatment (Eff. 1-1-09) (Rev. 1-1-12)	243
35	<input type="checkbox"/> Preventive Maintenance – Cape Seal (Eff. 1-1-09) (Rev. 1-1-12)	249
36	<input type="checkbox"/> Preventive Maintenance – Micro-Surfacing (Eff. 1-1-09) (Rev. 1-1-12)	264
37	<input type="checkbox"/> Preventive Maintenance – Slurry Seal (Eff. 1-1-09) (Rev. 1-1-12)	275
38	<input type="checkbox"/> Temporary Raised Pavement Markers (Eff. 1-1-09) (Rev. 1-1-14)	285
39	<input type="checkbox"/> Restoring Bridge Approach Pavements Using High-Density Foam (Eff. 1-1-09) (Rev. 1-1-12)	286

CHECK SHEET
FOR
LOCAL ROADS AND STREETS RECURRING SPECIAL PROVISIONS

Adopted January 1, 2014

The following LOCAL ROADS AND STREETS RECURRING SPECIAL PROVISIONS indicated by an "X" are applicable to this contract and are included by reference:

LOCAL ROADS AND STREETS RECURRING SPECIAL PROVISIONS

<u>CHECK SHEET #</u>	<u>PAGE NO.</u>
LRS 1	290
LRS 2	291
LRS 3	292
LRS 4	293
LRS 5	294
LRS 6	295
LRS 7	301
LRS 8	307
LRS 9	308
LRS 10	309
LRS 11	310
LRS 12	312
LRS 13	314
LRS 14	315
LRS 15	318
LRS 16	319
LRS 17	320
LRS 18	321

INDEX OF SPECIAL PROVISIONS

Page	Title
1	DESCRIPTION OF WORK
1	HOT-MIX ASPHALT SURFACE REMOVAL - BUTT JOINT
1	LEVELING BINDER (MACHINE METHOD) FG, N30
1	HOT-MIX ASPHALT SURFACE COURSE, MIXTURE C, N30
2	BITUMINOUS MATERIALS (PRIME COAT)
2	TRAFFIC CONTROL
2	PROSECUTION OF WORK
3	SPECIAL PROVISION FOR LRS 6 (BIDDING REQUIREMENTS AND CONDITIONS FOR CONTRACT PROPOSALS)
3	PREVAILING WAGE



Special Provisions

The following Special Provisions supplement the "Standard Specifications for Road and Bridge Construction", Adopted January 1, 2012, the latest edition of the "Manual on Uniform Traffic Control Devices for Streets and Highways", and the "Manual of Test Procedures of Materials" in effect on the date of invitation of bids, and the Supplemental Specifications and Recurring Special Provisions indicated on the Check Sheet included here in which apply to and govern the construction of Section 14-18000-02-GM, Sycamore Rd District, in case of conflict with any part, or parts, of said Specifications, the said Special Provisions shall take precedence and shall govern.

DESCRIPTION OF WORK The work of this section shall consist of placing varying thickness of Leveling Binder (Machine Method) N30 and/or Hot-Mix Asphalt Surface Course, Mix C, N30, and other incidental work on various roads in Sycamore Township for a total distance of 2.223 miles.

HOT-MIX ASPHALT SURFACE REMOVAL – BUTT JOINT This work shall be done in accordance with Section 406.08 of the Standard Specifications. The work shall consist of milling the existing pavement at various locations throughout the project.

The Butt Joints at the end of the project shall be 1 ¼" or 1 ½" deep tapered to 0" over 50 or 60 feet depending on surface lift thickness.

The Butt Joints at sideroads or at stop signs shall be 0" deep tapered to 1 ¼" or 1 ½" deep over 20 feet.

Butt Joints at entrances shall be done by others and not included in the cost of Hot-Mix Asphalt Surface Removal – Butt Joint.

Any and all Temporary Ramps required by the Engineer as per Article 406.08 will be considered incidental to this pay item.

Method of Measurement - Only that portion of the pavement that has been milled to a minimum depth of ¼" will be measured for payment. This work, including all milling, hauling and disposal of the millings shall be paid for at the contract unit price per square yard for Hot-Mix Asphalt Surface Removal – Butt Joint.

LEVELING BINDER (MACHINE METHOD) FG, N30 This work shall consist of placing a 1 ¼" Leveling Binder on an existing bituminous surface. This work shall be performed in accordance with Section 406 and 1030 of the Standard Specifications with the following exceptions:

Article 406.14 Basis of Payment - This work shall be paid for at the contract unit price per ton for Bituminous Materials (Prime Coat). Leveling Binder (Machine Method) FG, N30 shall include Quality Control as per Section 1030.

PG Grade	PG 64-22
Design Air Voids	4%
Mixture Composition	IL 9.5

Quantities are estimate prepared for the establishment of pay item prices and are the responsibility of the contractor to confirm prior to bidding. Quantities may be increased, decreased, or omitted to satisfactorily complete the project.

HOT-MIX ASPHALT SURFACE COURSE, MIXTURE C, N30 This work shall be done in accordance with Section 406 and 1030 of the Standard Specifications with the following exceptions:

Article 406.06 Placing - Delete (a) of this article.

Article 406.07 Compaction - (c) Density 1030.05 d. (3) Required Field Tests – Use LR 1030 “Special Provision for Growth Curve” included in this proposal.

Article 406.14 Basis of Payment - This work shall be paid for at the contract unit price per ton for Hot-Mix Asphalt Surface Course, Mixture C, N50 which price shall include Quality Control as per Section 1030 and all the work specified in this Special Provision.

PG Grade	PG 64-22
Design Air Voids	4% at N50
Mixture Composition	IL 9.5 or 12.5
Friction Aggregate	Mixture C

Quantities are estimate prepared for the establishment of pay item prices and are the responsibility of the contractor to confirm prior to bidding. Quantities may be increased, decreased, or omitted to satisfactorily complete the project.

BITUMINOUS MATERIALS (PRIME COAT) Asphalt SS-1 shall be used for BITUMINOUS MATERIALS (PRIME COAT) on the existing bituminous surfaces and shall be applied at the rate of 0.10 gallons per square yard or as directed by the Engineer. Asphalt SS-1 shall be used for BITUMINOUS MATERIALS (PRIME COAT) on the Leveling Binder (Machine Method), N30 and shall be applied at the rate of 0.025 gallons per square yard or as directed by the Engineer. This work shall be paid for at the contract unit price per Ton for BITUMINOUS MATERIALS (PRIME COAT).

TRAFFIC CONTROL Traffic Control shall be in accordance with the applicable sections of the Standard Specifications for Road and Bridge Construction, the applicable guidelines contained in the manual on Uniform Traffic Control Devices for Streets and Highways, these Special Provisions, and any special details and Highway Standards contained herein and in the plans.

Standards 701006, 701301, 701306, 701311, 701901, 780001, BLR 24-2.

The entire section shall remain open to a minimum of one lane traffic during construction. After hours of operation each day, the contractor shall open both lanes to overnight traffic.

Access shall be maintained for those living on all roads under this contract in accordance with Article 107.09 of the Standard Specifications.

The presence of temporary traffic control drawings or standards in the project plans, whether a pay item or not, does not relieve the contractor of his obligation to the public, in accordance with Article 107.14 of the Standard Specifications for Road and Bridge Construction. The contractor shall provide, to the satisfaction of the Engineer, all protection deemed necessary beyond that shown in the plans or Special Provisions.

“BUMP” signs shall be installed as directed by the Engineer.

Flaggers shall comply with all requirements contained in the Department’s “Flagger Handbook” with the following exception: The ANSI Class 2 vest will not be supplied by the Department.

The cost of any and all traffic control required by these special provisions and the standards included in this proposal shall be considered incidental to the contract.

PROSECUTION OF WORK The Contractor shall notify the Engineer a minimum of two (2) working days (i.e. notice given on Thursday A.M. for work to begin the following Monday) prior to commencement of any work which would be considered as a pay item in the contract. No payment will be made to the Contractor for any pay item work performed without the aforementioned notice being given unless otherwise approved by the Engineer. Work shall be performed during daylight hours only.

SPECIAL PROVISION FOR LRS 6 (BIDDING REQUIREMENTS AND CONDITIONS FOR CONTRACT PROPOSALS)

Prequalification of Bidders The provisions for prequalification of bidders as stated in the second paragraph shall apply to this proposal.

A current Certificate of Eligibility must be presented prior to receiving bidding documents.

Revise the second paragraph of this special provision to read:

"All bidders must file at the time of the letting a sworn affidavit showing all uncompleted contracts awarded to them and all low bids pending award for federal, state, county, municipal, and private work, using blank forms made available for this affidavit. All copies shall be filed with the awarding authority."

PREVAILING WAGE

The Contractor(s) shall pay prevailing wage to employees on this project in accordance with LR107-7. The Contractor shall be responsible for obtaining the monthly rate sheet from the Illinois Department of Labor. These sheets are also available at the DeKalb County Clerk's office or at:

<http://www.illinois.gov/idol/Laws-Rules/CONMED/Pages/Rates.aspx>

State of Illinois
Department of Transportation
Bureau of Local Roads and Streets

SPECIAL PROVISION
FOR
BIDDING REQUIREMENTS AND CONDITIONS FOR CONTRACT PROPOSALS

Effective: January 1, 2001
Revised: January 1, 2014

All references to Sections or Articles in this specification shall be construed to mean specific Section or Article of the Standard Specifications for Road and Bridge Construction, adopted by the Department of Transportation.

Replace Article 102.01 of the Standard Specifications with the following:

“Prequalification of Bidders. When prequalification is required and the Awarding Authority for contract construction work is the County Board of a County, the Council, the City Council, or the President and Board of Trustees of a city, village, or town, each prospective bidder, in evidence of competence, shall furnish the Awarding Authority as a prerequisite to the release of proposal forms by the Awarding Authority, a certified or photostatic copy of a "Certificate of Eligibility" issued by the Department of Transportation, according to the Department's "Prequalification Manual".

The two low bidders must file, within 24 hours after the letting, a sworn affidavit in triplicate, showing all uncompleted contracts awarded to them and all low bids pending award for Federal, State, County, Municipal and private work, using the blank form made available for this affidavit. One copy shall be filed with the Awarding Authority and two copies with IDOT's District office.

Issuance of Proposal Forms. The Awarding Authority reserves the right to refuse to issue a proposal form for bidding purposes for any of the following reasons:

- (a) Lack of competency and adequate machinery, plant, and other equipment, as revealed by the financial statement and experience questionnaires required in the prequalification procedures.
- (b) Uncompleted work which, in the judgment of the Awarding Authority, might hinder or prevent the prompt completion of additional work awarded.
- (c) False information provided on a bidder's "Affidavit of Availability".
- (d) Failure to pay, or satisfactorily settle, all bills due for labor and material on former contracts in force at the time of issuance of proposal forms.
- (e) Failure to comply with any prequalification regulations of the Department.
- (f) Default under previous contracts.
- (g) Unsatisfactory performance record as shown by past work for the Awarding Authority, judged from the standpoint of workmanship and progress.
- (h) When the Contractor is suspended from eligibility to bid at a public letting where the contract is awarded by, or requires approval of, the Department.
- (i) When any agent, servant, or employee of the prospective bidder currently serves as a member, employee, or agent of a governmental body that is financially involved in the proposal work.

- (j) When any agent, servant, or employee of the perspective bidder has participated in the preparation of plans or specifications for the proposed work.

Interpretation of Quantities in the Bid Schedule. The quantities appearing in the bid schedule are approximate and are prepared for the comparison of bids. Payment to the Contractor will be made only for the actual quantities of work performed and accepted or materials furnished according to the contract. The scheduled quantities of work to be done and materials to be furnished may be increased, decreased, or omitted as hereinafter provided.

Examination of Plans, Specifications, Special Provisions, and Site of Work. The bidder shall, before submitting a bid, carefully examine the provisions of the contract. The bidder shall inspect in detail the site of the proposed work, investigate and become familiar with all the local conditions affecting the contract and fully acquaint themselves with the detailed requirements of construction. Submission of a bid shall be a conclusive assurance and warranty the bidder has made these examinations and the bidder understands all requirements for the performance of the work. If his/her bid is accepted, the bidder shall be responsible for all errors in the proposal resulting from his/her failure or neglect to comply with these instructions. The Awarding Authority will, in no case, be responsible for any costs, expenses, losses, or change in anticipated profits resulting from such failure or neglect of the bidder to make these examinations.

The bidder shall take no advantage of any error or omission in the proposal and advertised contract. Any prospective bidder, who desires an explanation or interpretation of the plans, specification, or any of the contract documents, shall request such in writing from the Awarding Authority, in sufficient time to allow a written reply by the Awarding Authority that can reach all prospective bidders before the submission of their bids. Any reply given a prospective bidder concerning any of the contract documents, plans, and specifications will be furnished to all prospective bidders in the form determined by the Awarding Authority including, but not limited to, an addendum, if the information is deemed by the Awarding Authority to be necessary in submitting bids or if the Awarding Authority concludes the information would aid competition. Oral explanations, interpretations, or instructions given before the submission of bids unless at a prebid conference will not be binding on the Awarding Authority.

Preparation of the Proposal. Bidders shall submit their proposals on the form furnished by the Awarding Authority. The proposal shall be executed properly, and bids shall be made for all items indicated in the proposal form, except when alternate bids are asked, a bid on more than one alternate for each item is not required, unless otherwise provided. The bidder shall indicate in figures, a unit price for each of the separate items called for in the proposal form; the bidder shall show the products of the respective quantities and unit prices in the column provided for that purpose, and the gross sum shown in the place indicated in the proposal form shall be the summation of said products. All writing shall be with ink or typewriter, except the signature of the bidder which shall be written in ink.

If the proposal is made by an individual, that individual's name and business address shall be shown. If made by a firm or partnership, the name and business address of each member of the firm or partnership shall be shown. If made by a corporation, the proposal shall show the names, titles, and business addresses of the president, corporate secretary and treasurer. The proposal shall be signed by president or someone with authority to execute contracts and attested by the corporate secretary or someone with authority to execute or attest to the execution of contracts.

When prequalification is required, the proposal form shall be submitted by an authorized bidder in the same name and style as shown on the "Contractor's Statement of Experience and Financial Condition" used for prequalification.

Rejection of Proposals. The Awarding Authority reserves the right to reject any proposal for any of the conditions in "Issuance of Proposal Forms" or for any of the following reasons:

- (a) More than one proposal for the same work from an individual, firm, partnership, or corporation under the same name or different names.
- (b) Evidence of collusion among bidders.
- (c) Unbalanced proposals in which the bid prices for some items are, in the judgment of the Awarding Authority, out of proportion to the bid prices for other items.
- (d) If the proposal does not contain a unit price for each pay item listed, except in the case of authorized alternate pay items or lump sum pay items.
- (e) If the proposal form is other than that furnished by the Awarding Authority; or if the form is altered or any part thereof is detached.
- (f) If there are omissions, erasures, alterations, unauthorized additions, conditional or alternate bids, or irregularities of any kind which may tend to make the proposal incomplete, indefinite or ambiguous as to its meaning.
- (g) If the bidder adds any provisions reserving the right to accept or reject an award, or to enter into a contract pursuant to an award.
- (h) If the proposal is not accompanied by the proper proposal guaranty.
- (i) If the proposal is prepared with other than ink or typewriter, or otherwise fails to meet the requirements of the above "Preparation of Proposal" section.

Proposal Guaranty. Each proposal shall be accompanied by a bid bond on the Department form contained in the proposal, executed by a corporate surety company satisfactory to the Awarding Authority, by a bank cashier's check or a properly certified check for not less than five percent of the amount bid, or for the amount specified in the following schedule:

<u>Amount Bid</u>		<u>Proposal Guaranty</u>
Up to	\$5,000	\$150
>\$5,000	\$10,000	\$300
>\$10,000	\$50,000	\$1,000
>\$50,000	\$100,000	\$3,000
>\$100,000	\$150,000	\$5,000
>\$150,000	\$250,000	\$7,500
>\$250,000	\$500,000	\$12,500
>\$500,000	\$1,000,000	\$25,000
>\$1,000,000	\$1,500,000	\$50,000
>\$1,500,000	\$2,000,000	\$75,000
>\$2,000,000	\$3,000,000	\$100,000
>\$3,000,000	\$5,000,000	\$150,000
>\$5,000,000	\$7,500,000	\$250,000
>\$7,500,000	\$10,000,000	\$400,000
>\$10,000,000	\$15,000,000	\$500,000
>\$15,000,000	\$20,000,000	\$600,000
>\$20,000,000	\$25,000,000	\$700,000
>\$25,000,000	\$30,000,000	\$800,000
>\$30,000,000	\$35,000,000	\$900,000
Over	\$35,000,000	\$1,000,000

In the event that one proposal guaranty check is intended to cover two or more proposals, the amount must equal to the sum of the proposal guaranties which would be required for each individual proposal.

Bank cashier's checks or properly certified checks accompanying proposals shall be made payable to the County Treasurer, when a County is the Awarding Authority; or the City, Village, or Town Treasurer, when a city, village, or town is the Awarding Authority.

The proposal guaranty checks of all, except the two lowest responsible, will be returned promptly after the proposals have been checked, tabulated, and the relation of the proposals established. Proposal guaranty checks of the two lowest bidders will be returned as soon as the contract and contract bond of the successful bidder have been properly executed and approved. Bid bonds will not be returned.

After a period of three working days has elapsed after the date of opening proposals, the Awarding Authority may permit the two lowest bidders to substitute for the bank cashier's checks or certified checks submitted with their proposals as proposal guaranties, bid bonds on the Department forms executed by corporate surety companies satisfactory to the Awarding Authority.

Delivery of Proposals. If a special envelope is supplied by the Awarding Authority, each proposal should be submitted in that envelope furnished by the Awarding Authority and the blank spaces on the envelope shall be filled in correctly to clearly indicate its contents. When an envelope other than the special one furnished by the Awarding Authority is used, it shall be marked to clearly indicate its contents. When sent by mail, the sealed proposal shall be addressed to the Awarding Authority at the address and in care of the official in whose office the bids are to be received. All proposals shall be filed prior to the time and at the place specified in the Notice to Bidders. Proposals received after the time specified will be returned to the bidder unopened.

Withdrawal of Proposals. Permission will be given a bidder to withdraw a proposal if the bidder makes the request in writing or in person before the time for opening proposals.

Public Opening of Proposals. Proposals will be opened and read publicly at the time and place specified in the Notice to Bidders. Bidders, their authorized agents, and other interested parties are invited to be present.

Consideration of Proposals. After the proposals are opened and read, they will be compared on the basis of the summation of the products of the quantities shown in the bid schedule by the unit bid prices. In awarding contracts, the Awarding Authority will, in addition to considering the amounts stated in the proposals, take into consideration the responsibility of the various bidders as determined from a study of the data required under "Prequalification of Bidders", and from other investigations which it may elect to make.

The right is reserved to reject any or all proposals, to waive technicalities, or to advertise for new proposals, if in the judgment of the Awarding Authority, the best interests of the Awarding Authority will be promoted thereby.

Award of Contract. The award of contract will be made within 45 calendar days after the opening of proposals to the lowest responsible and qualified bidder whose proposal complies with all the requirements prescribed. The successful bidder will be notified by letter of intent that his/her bid has been accepted, and subject to the following conditions, the bidder will be the Contractor.

An approved contract executed by the Awarding Authority is required before the Awarding Authority is bound. An award may be cancelled any time by the Awarding Authority prior to execution in order to protect the public interest and integrity of the bidding process or for any other reason if, in the judgment of the Awarding Authority, the best interests of the Awarding Authority will be promoted thereby.

If a contract is not awarded within 45 days after the opening of proposals, bidders may file a written request with the Awarding Authority for the withdrawal of their bid, and the Awarding Authority will permit such withdrawal.

Requirement of Contract Bond. If the Awarding Authority requires a Contract Bond, the Contractor or Supplier shall furnish the Awarding Authority a performance and payment bond with good and sufficient sureties in the full amount of the award as the penal sum. The surety shall be acceptable to the Awarding Authority, shall waive notice of any changes and extensions of time, and shall submit its bond on the form furnished by the Awarding Authority.

Execution of Contract. The contract shall be executed by the successful bidder and returned, together with the Contract Bond, within 15 days after the contract has been mailed to the bidder.

If the bidder to whom the award is made is a corporation organized under the laws of a State other than Illinois, the bidder shall furnish the Awarding Authority a copy of the corporation's Certificate of Authority to do business in the State of Illinois with the return of the executed contract and bond. Failure to furnish such evidence of a Certificate of Authority within the time required will be considered as just cause for the annulment of the award and the forfeiture of the proposal guaranty to the Awarding Authority, not as a penalty, but in payment of liquidated damages sustained as a result of such failure.

Failure to Execute Contract. If the contract is not executed by the Awarding Authority within 15 days following receipt from the bidder of the properly executed contracts and bonds, the bidder shall have the right to withdraw his/her bid without penalty.

Failure of the successful bidder to execute the contract and file acceptable bonds within 15 days after the contract has been mailed to the bidder shall be just cause for the cancellation of the award and the forfeiture of the proposal guaranty which shall become the property of the Awarding Authority, not as penalty, but in liquidation of damages sustained. Award may then be made to the next lowest responsible bidder, or the work may be readvertised and constructed under contract, or otherwise, as the Awarding Authority may decide.”

State of Illinois
Department of Transportation
Bureau of Local Roads and Streets

SPECIAL PROVISION
FOR
COOPERATION WITH UTILITIES

Effective: January 1, 1999
Revised: January 1, 2007

All references to Sections or Articles in this specification shall be construed to mean specific Section or Article of the Standard Specifications for Road and Bridge Construction, adopted by the Department of Transportation.

Replace Article 105.07 of the Standard Specifications with the following:

“105.07 Cooperation with Utilities. The adjustment of utilities consists of the relocation, removal, replacement, rearrangements, reconstruction, improvement, disconnection, connection, shifting, new installation or altering of an existing utility facility in any manner.

When the plans or special provisions include information pertaining to the location of underground utility facilities, such information represents only the opinion of the Department as to the location of such utilities and is only included for the convenience of the bidder. The Department assumes no responsibility in respect to the sufficiency or the accuracy of the information shown on the plans relative to the location of the underground utility facilities.

Utilities which are to be adjusted shall be adjusted by the utility owner or the owner's representative or by the Contractor as a contract item. Generally, arrangements for adjusting existing utilities will be made by the Department prior to project construction; however, utilities will not necessarily be adjusted in advance of project construction and, in some cases, utilities will not be removed from the proposed construction limits. When utility adjustments must be performed in conjunction with construction, the utility adjustment work will be shown on the plans and/or covered by Special Provisions.

When the Contractor discovers a utility has not been adjusted by the owner or the owner's representative as indicated in the contract documents, or the utility is not shown on the plans or described in the Special Provisions as to be adjusted in conjunction with construction, the Contractor shall not interfere with said utility, and shall take proper precautions to prevent damage or interruption of the utility and shall promptly notify the Engineer of the nature and location of said utility.

All necessary adjustments, as determined by the Engineer, of utilities not shown on the plans or not identified by markers, will be made at no cost to the Contractor except traffic structures, light poles, etc., that are normally located within the proposed construction limits as hereinafter defined will not be adjusted unless required by the proposed improvement.

(a) Limits of Proposed Construction for Utilities Paralleling the Roadway. For the purpose of this Article, limits of proposed construction for utilities extending in the same longitudinal direction as the roadway, shall be defined as follows:

(1) The horizontal limits shall be a vertical plane, outside of, parallel to, and 600 mm (2 ft) distant at right angles from the plan or revised slope limits.

In cases where the limits of excavation for structures are not shown on the plans, the horizontal limits shall be a vertical plane 1.2 m (4 ft) outside the edges of structure footings or the structure where no footings are required.

(2) The upper vertical limits shall be the regulations governing the roadbed clearance for the specific utility involved.

(3) The lower vertical limits shall be the top of the utility at the depth below the proposed grade as prescribed by the governing agency or the limits of excavation, whichever is less.

(b) Limits of Proposed Construction for Utilities Crossing the Roadway. For the purpose of this Article, limits of proposed construction for utilities crossing the roadway in a generally transverse direction shall be defined as follows:

(1) Utilities crossing excavations for structures that are normally made by trenching such as sewers, underdrains, etc. and all minor structures such as manholes, inlets, foundations for signs, foundations for traffic signals, etc., the limits shall be the space to be occupied by the proposed permanent construction unless otherwise required by the regulations governing the specific utility involved.

(2) For utilities crossing the proposed site of major structures such as bridges, sign trusses, etc., the limits shall be as defined above for utilities extending in the same general direction as the roadway.

The Contractor may make arrangements for adjustment of utilities outside of the limits of proposed construction provided the Contractor furnishes the Department with a signed agreement with the utility owner covering the adjustments to be made. The cost of any adjustments made outside the limits of proposed construction shall be the responsibility of the Contractor unless otherwise provided.

The Contractor shall request all utility owners to field locate their facilities according to Article 107.31. The Engineer may make the request for location from the utility after receipt of notice from the Contractor. On request, the Engineer will make an inspection to verify that the utility company has field located its facilities, but will not assume responsibility for the accuracy of such work. The Contractor shall be responsible for maintaining the excavations or markers provided by the utility owners. This field location procedure may be waived if the utility owner has stated in writing to the Department it is satisfied the construction plans are sufficiently accurate. If the utility owner does not submit such statement to the Department, and they do not field locate their facilities in both horizontal and vertical alignment, the Engineer will authorize the Contractor in writing to proceed to locate the facilities in the most economical and reasonable manner, subject to the approval of the Engineer, and be paid according to Article 109.04.

The Contractor shall coordinate with any planned utility adjustment or new installation and the Contractor shall take all precautions to prevent disturbance or damage to utility facilities. Any failure on the part of the utility owner, or their representative, to proceed with any planned utility adjustment or new installation shall be reported promptly by the Contractor to the Engineer orally and in writing.

The Contractor shall take all necessary precautions for the protection of the utility facilities. The Contractor shall be responsible for any damage or destruction of utility facilities resulting from neglect, misconduct, or omission in the Contractor's manner or method of execution or nonexecution of the work, or caused by defective work or the use of unsatisfactory materials. Whenever any damage or destruction of a utility facility occurs as a result of work performed by the Contractor, the utility company will be immediately notified. The utility company will make arrangements to restore such facility to a condition equal to that existing before any such damage or destruction was done.

It is understood and agreed that the Contractor has considered in the bid all of the permanent and temporary utilities in their present and/or adjusted positions.

No additional compensation will be allowed for any delays, inconvenience, or damage sustained by the Contractor due to any interference from the said utility facilities or the operation of relocating the said utility facilities.

State of Illinois
Department of Transportation
Bureau of Local Roads and Streets

SPECIAL PROVISION
FOR
INSURANCE

Effective: February 1, 2007
Revised: August 1, 2007

All references to Sections or Articles in this specification shall be construed to mean specific Section or Article of the Standard Specifications for Road and Bridge Construction, adopted by the Department of Transportation.

The Contractor shall name the following entities as additional insured under the Contractor's general liability insurance policy in accordance with Article 107.27:

The entities listed above and their officers, employees, and agents shall be indemnified and held harmless in accordance with Article 107.26.

State of Illinois
DEPARTMENT OF TRANSPORTATION
Bureau of Local Roads & Streets

SPECIAL PROVISION
FOR
WAGES OF EMPLOYEES ON PUBLIC WORKS

Effective: January 1, 1999
Revised: January 1, 2012

1. Prevailing Wages. All wages paid by the Contractor and each subcontractor shall be in compliance with The Prevailing Wage Act (820 ILCS 130), as amended, except where a prevailing wage violates a federal law, order, or ruling, the rate conforming to the federal law, order, or ruling shall govern. The Contractor shall be responsible to notify each subcontractor of the wage rates set forth in this contract and any revisions thereto. If the Department of Labor revises the wage rates, the revised rate as provided by the public body shall apply to this contract and the Contractor will not be allowed additional compensation on account of said revisions.
2. Payroll Records. The Contractor and each subcontractor shall make and keep, for a period of not less than three years from the date of the last payment on a contract or subcontract, records of all laborers, mechanics, and other workers employed by them on the project; the records shall include each worker's name, address, telephone number when available, social security number, classification or classifications, the hourly wages paid in each pay period, the number of hours worked each day, and the starting and ending times of work each day. Upon seven business days' notice, the Contractor and each subcontractor shall make available for inspection and copying at a location within this State during reasonable hours, the payroll records to the public body in charge of the project, its officers and agents, the Director of Labor and his deputies and agents, and to federal, State, or local law enforcement agencies and prosecutors.
3. Submission of Payroll Records. The Contractor and each subcontractor shall no later than the tenth day of each calendar month file a certified payroll for the immediately preceding month with the public body in charge of the project, except that the full social security number and home address shall not be included on weekly transmittals. Instead the payrolls shall include an identification number for each employee (e.g., the last four digits of the employee's social security number). The certified payroll shall consist of a complete copy of the payroll records except starting and ending times of work each day may be omitted

The certified payroll shall be accompanied by a statement signed by the Contractor or subcontractor or an officer, employee, or agent of the contractor or subcontractor which avers that: (i) he or she has examined the certified payroll records required to be submitted by the Act and such records are true and accurate; (ii) the hourly rate paid to each worker is not less than the general prevailing rate of hourly wages required; and (iii) the Contractor or subcontractor is aware that filing a certified payroll that he or she knows to be false is a Class A misdemeanor.
4. Employees Interviews. The Contractor and each subcontractor shall permit his/her employees to be interviewed on the job, during working hours, by compliance investigators of the Department or the Department of Labor.

State of Illinois
DEPARTMENT OF TRANSPORTATION
Bureau of Local Roads & Streets

SPECIAL PROVISION
FOR
GROWTH CURVE

Effective: March 1, 2008
Revised: January 1, 2010

All references to Sections and Articles in this Special Provision shall be construed to mean specific Sections and Articles in the Standard Specifications for Road and Bridge Construction adopted by the Department of Transportation.

The Contractor shall perform a growth curve at the beginning of placement of each type of mix and each lift. The growth curve for each type of mix and each lift shall be performed within the first 200 tons (180 metric tons). If an adjustment is made to the specific mix design, the Engineer reserves the right to request an additional growth curve and supporting tests at the Contractor's expense.

Compaction of the growth curve shall commence immediately after the course is placed and at a temperature of not less than 280 °F (140 °C). The growth curve, consisting of a plot of lb/cu ft (kg/cu m) vs. number of passes with the project breakdown roller, shall be developed. Roller speed during the growth curve testing shall be the same as the normal paving operation. This curve shall be established by use of a nuclear gauge. Tests shall be taken after each pass until the highest lb/cu ft (kg/cu m) is obtained. This value shall be the target density provided the HMA Gyratory air voids are within acceptable limits. If the HMA Gyratory air voids are not within the specified limits, corrective action shall be taken, and a new target density shall be established.

A new growth curve is required if the breakdown roller used on the growth curve is replaced with a new roller during production. The target density shall apply only to the specific gauge used. If additional gauges are to be used to determine density specification compliance, the Contractor shall establish a unique minimum allowable target density from the growth curve location for each gauge.

At least one core sample per day shall be taken at a location specified by the Engineer. Core densities will be determined using the Illinois-Modified AASHTO T 166 or T 275 procedure by the Department. The core density shall be according to Articles 1030.05(d)(4) and (d)(7). The QA Manager is responsible for assuring and documenting that the determined number of roller passes has been accomplished. The Engineer reserves the right to take core samples at any time to verify density from the nuclear gauge,

All lifts and confined longitudinal joint edges shall be compacted to an average nuclear gauge density of not less than 95 percent nor greater than 102 percent of the target density obtained on the growth curve. Unconfined longitudinal joint edges shall be compacted to an average nuclear gauge density of not less than 93 percent nor greater than 102 percent of the target density obtained on the growth curve. The average nuclear gauge density shall be based on tests representing one day's production.

Quality Control density tests shall be performed at randomly selected locations within 1/2 mile (800 m) intervals per lift per lane. In no case shall more than one half day's production be completed without density testing being performed. Longitudinal joint density testing shall be performed at each random density test location. Longitudinal joint testing shall be located at a distance equal to the lift thickness or a minimum of 2 in. (50 mm) from each pavement edge.

If the Contractor is not controlling the compaction process and is making no effort to take corrective action, the operation shall stop as directed by the Engineer.

State of Illinois
DEPARTMENT OF TRANSPORTATION
Bureau of Local Roads & Streets

SPECIAL PROVISION
FOR
EMULSIFIED ASPHALTS

Effective: January 1, 2007
Revised: February 7, 2008

All references to Sections and Articles in this Special Provision shall be construed to mean specific Sections and Articles in the Standard Specifications for Road and Bridge Construction adopted by the Department of Transportation.

Replace the table after Note 2 in Article 403.02 with the following:

Type of Construction	Bituminous Materials Recommended for Weather Conditions Indicated	
	Warm [15 °C to 30 °C]* [(60 °F to 85 °F)]*	Hot [30 °C Plus]* [(85 °F Plus)]*
Prime	MC-30, PEP	MC-30, PEP
Cover Coat and Seal Coat	RS-2, CRS-2, RC-800, RC-3000, MC-800, MC-3000, SC-3000, HFE-90, HFE-150, HFE-300, HFRS-2, PEA**	RS-2, CRS-2, RC-800, RC-3000, MC-800, MC-3000, SC-3000, PG46-28, PG52-28, HFE-90, HFE-150, HFE-300, HFRS-2, PEA**

* Temperature of the air in the shade at the time of application.

** PEA is only allowed on roads with low traffic volumes

Replace the table after Note 2 in Article 406.02 with the following:

Type of Construction	Bituminous Materials Recommended
Prime (tack) on Brick, Concrete, or Bituminous Bases (Note 3)	SS-1, SS-1h, CSS-1, CSS-1h, HFE-90, RC-70
Prime on Aggregate Bases (Note 4)	MC-30, PEP
Mixture for Cracks, Joints, and Flangeways	PG58-22, PG64-22

Note 3. When emulsified asphalts are used, they shall be diluted with an equal volume of potable water. HFE emulsions shall be diluted by the manufacturer. The diluted material shall be thoroughly agitated within 24 hours of application and show no separation of water and emulsion. The diluted material shall not be returned to an approved emulsion storage tank.

Note 4. Preparation of the bituminous PEP shall be as specified in Article 403.05.

Replace the table in Article 1032.04 with the following:

Spraying Application Temperature Ranges		
Type and Grade of Bituminous Material	Temperature Ranges	
	°F min. - max.	°C min. - max.
PEP	60 - 130	15 - 55
PEA	140 - 190	60 - 88
MC-30	85 - 190	30 - 90
MC-70, RC-70, SC-70	120 - 225	50 - 105
MC-250, SC-250	165 - 270	75 - 130
MC-800, SC-800	200 - 305	95 - 150
MC-3000, SC-3000	230 - 345	110 - 175
PG46-28	275 - 385	135 - 195
PG52-28	285 - 395	140 - 200
RS-2, CRS-2	110 - 160	45 - 70
SS-1, SS-1h, CSS-1, CSS-1h	75 - 130	25 - 55
SS-1hP, CSS-1hP	75 - 130	25 - 55
HFE-90, HFE-150, HFE-300	150 - 180	65 - 80
HFP, CRSP, HFRS-2	150 - 180	65 - 80
E-2	85 - 190	30 - 90
E-3	120 - 225	50 - 105
E-4	165 - 270	75 - 130

Add subparagraph (g) to Article 1032.06:

- (g) Penetrating Emulsified Asphalt (PEA). The penetrating emulsified asphalt shall meet the following requirements when tested according to AASHTO T59:

Viscosity, Saybolt Fural @ 25°C (77°F),	sec:	20 - 500
Sieve Test, retained on 850 μm (No. 20) sieve, maximum,	%:	0.10
Storage Stability Test, 1 day, maximum,	%:	1
Float Test @ 60°C (140°F), minimum,	sec:	150
Stone Coating Test, 3 minutes,	:	Stone Coated Thoroughly
Particle Charge	:	Negative
pH, minimum	:	7.3
Distillation Test:		
Distillation to 260°C (500°F) Residue, minimum	%:	65
Oil Distillate by Volume, maximum	%:	3
Test on residue from distillation:		
Penetration @ 25°C (77°F), 100 g, 5 sec, minimum	dmm:	300

Replace the last sentence and table of Article 1032.06 with the following:

The different grades are, in general, used for the following.

Grade	Use
SS-1, SS-1h, CSS-1, CSS-1h, HFE 90, SS-1hP, CSS-1hP	Tack or fog seal
PEP	Bituminous surface treatment prime
RS-2, HFE 90, HFE 150, HFE 300, CRSP, HFP, CRS-2, HFRS-2, PEA	Bituminous surface treatment
CSS-1h Latex Modified	Microsurfacing

HOT-MIX ASPHALT MIXTURE IL-9.5FG (BMPR)

Effective: July 1, 2005
 Revised: December 28, 2010

Description. This work shall consist of constructing fine graded hot-mix asphalt (HMA) surface course or leveling binder with an IL-9.5FG mixture. Work shall be according to Sections 406, 407 and 1030 of the Standard Specifications, except as modified herein.

Materials. Revise Article 1003.03(c) of the Standard Specifications to read:

“(c) Gradation. The fine aggregate gradation for all HMA shall be FA 1, FA 2, FA 20, or FA 21. For mixture IL-9.5FG, the fine aggregate fraction shall consist of at least 67 percent manufactured sand meeting FA 20 gradation. The manufactured sand shall be stone sand, slag sand, steel slag sand, or combinations thereof.”

Mixture Design. Add the following to the table in Article 1030.04(a)(1) of the Standard Specifications:

“High ESAL, MIXTURE COMPOSITION (% PASSING) ^{1/}		
Sieve Size	IL-9.5FG	
	min	max
1 1/2 in (37.5 mm)		
1 in. (25 mm)		
3/4 in. (19 mm)		
1/2 in. (12.5 mm)		100
3/8 in. (9.5 mm)	90	100
#4 (4.75 mm)	60 ^{4/}	75 ^{4/}
#8 (2.36 mm)	45 ^{4/}	60 ^{4/}
#16 (1.18 mm)	25	40
#30 (600 μm)	15	30
#50 (300 μm)	8	15
#100 (150 μm)	6	10
#200 (75 μm)	4	6.5
Ratio Dust/Asphalt Binder		1.0

4/ When used as level binder placed less than 1 in. (25 mm) thick, the min. and max. percent passing shall each be increased 5%.”

Revise the table in Article 1030.04(b)(1) of the Standard Specifications to read:

“VOLUMETRIC REQUIREMENTS High ESAL					
	Voids in the Mineral Aggregate (VMA), % minimum				Voids Filled with Asphalt Binder (VFA),%
N _{design}	IL-25.0	IL-19.0	IL-12.5	IL-9.5	

50	12.0	13.0	14.0	15 ^{1/}	65 - 78
70					65 - 75 ^{2/}
90					
105					

1/ The VMA for IL-9.5FG shall be a minimum of 15.0 percent.

2/ The VFA range for IL-9.5FG shall be 65 - 78 percent.”

Quality Control/Quality Assurance (QC/QA). Revise the second table in Article 1030.05(d)(4) of the Standard Specifications to read:

"DENSITY CONTROL LIMITS		
Mixture Composition	Parameter	Individual Test ^{3/}
IL-9.5FG	Lifts < 1.25 in. (32 mm)	N _{design} 50 - 105
	Lifts ≥ 1.25 in. (32 mm)	N _{design} 50 - 105
IL-9.5, IL-12.5	N _{design} ≥ 90	92.0 – 96.0 %
IL-9.5, IL-9.5L, IL-12.5	N _{design} < 90	92.5 – 97.4 %
IL-19.0, IL-25.0	N _{design} ≥ 90	93.0 – 96.0 %
IL-19.0, IL-19.0L, IL-25.0	N _{design} < 90	93.0 – 97.4 %
All Other	N _{design} = 30	93.0 ^{1/} - 97.4 %

1/ 92.0 % when placed as first lift on an unimproved subgrade.

2/ Density shall be determined by cores or by correlated, approved thin lift nuclear gauge.

3/ Bulk Specific Gravity and Density that are determined using coated samples must be in accordance with ASTM 1188-96.”

CONSTRUCTION REQUIREMENTS

Leveling Binder. Revise the table and second paragraph of Article 406.05(c) of the Standard Specifications to read:

"Leveling Binder	
Nominal, Compacted, Leveling Binder Thickness, in. (mm)	Mixture Composition
≤ 1 1/4 (32)	IL-9.5, IL-9.5 FG, or IL-9.5L
> 1 1/4 to 2 (32 to 50)	IL-9.5, IL-9.5FG, IL-9.5L, or IL-12.5

The density requirements of Article 1030.05(d)(4) shall apply for leveling binder, machine method, when the nominal, compacted thickness is: 3/4 in. (19 mm) or greater for IL-9.5FG mixtures, 1 1/4 in. (32 mm) or greater for IL-9.5 and IL-9.5L mixtures, and 1 1/2 in. (38 mm) or greater for IL-12.5 mixtures.”

Compaction. Revise Table 1 in Article 406.07(a) of the Standard Specifications to read:

"TABLE 1 - MINIMUM ROLLER REQUIREMENTS FOR HMA				
	Breakdown Roller (one of the following)	Intermediate Roller	Final Roller (one or more of the following)	Density Requirement
Level Binder: (When the density requirements of Article 406.05(c) do not apply.)	P ^{3/}	- -	VS, P ^{3/} , TB, TF, 3W	To the satisfaction of the Engineer.
Level Binder: (When placed at ≤ 1 1/4 in. (32 mm) and density requirements apply.)	TB, 3W	P ^{3/}	VS, TB, TF	As specified in Articles: 1030.05(d)(3), (d)(4), and (d)(7).
Binder and Surface ^{1/} (When the density requirements of Article 406.05(c) apply.)	VD, P ^{3/} , TB, 3W	P ^{3/}	VS, TB, TF	As specified in Articles: 1030.05(d)(3), (d)(4), and (d)(7).
Bridge Decks ^{2/}	TB	- -	TF	As specified in Articles: 582.05 and 582.06.

1/ If the average delivery at the job site is 85 ton/hr (75 metric ton/hr) or less, any roller combination may be used provided it includes a steel wheeled roller and the required density and smoothness is obtained.

2/ One TB may be used for both breakdown and final rolling on bridge decks 300 ft (90 m) or less in length, except when the air temperature is less than 60 °F (15 °C).

3/ A vibratory roller (VD) may be used in lieu of the pneumatic-tired roller on mixtures containing polymer modified asphalt binder.

Basis of Payment. Add the following two paragraphs after the third paragraph of Article 406.14 of the Standard Specifications:

"Mixture IL-9.5FG will be paid for at the contract unit price per ton (metric ton) for LEVELING BINDER (HAND METHOD), IL-9.5FG, of the Ndesign specified; LEVELING BINDER (MACHINE METHOD), IL-9.5FG, of the Ndesign specified; or HOT-MIX ASPHALT SURFACE COURSE, IL-9.5FG, of the Ndesign specified.

Mixture IL-9.5FG in which polymer modified asphalt binders are required will be paid for at the contract unit price per ton (metric ton) for POLYMERIZED LEVELING BINDER (HAND METHOD), IL-9.5FG, of the Ndesign specified; POLYMERIZED LEVELING BINDER (MACHINE METHOD), IL-9.5FG, of the Ndesign specified; or POLYMERIZED HOT-MIX ASPHALT SURFACE COURSE, IL-9.5FG, of the Ndesign specified.”

De Kalb County Prevailing Wage for March 2014

(See explanation of column headings at bottom of wages)

Trade Name	RG	TYP	C	Base	FRMAN	M-F>8	OSA	OSH	H/W	Pensn	Vac	Trng
=====	==	===	=	=====	=====	=====	===	===	=====	=====	=====	=====
ASBESTOS ABT-GEN		BLD		30.570	31.820	1.5	1.5	2.0	8.240	12.95	0.000	0.800
ASBESTOS ABT-MEC		BLD		35.100	37.600	1.5	1.5	2.0	11.17	10.76	0.000	0.720
BOILERMAKER		BLD		44.240	48.220	2.0	2.0	2.0	6.970	17.54	0.000	0.350
BRICK MASON		BLD		41.580	45.740	1.5	1.5	2.0	9.700	12.80	0.000	1.040
CARPENTER		BLD		36.940	41.000	1.5	1.5	2.0	9.440	14.50	0.000	0.600
CARPENTER		HWY		34.880	36.630	1.5	1.5	2.0	10.50	14.00	0.000	0.490
CEMENT MASON		ALL		41.550	43.550	2.0	1.5	2.0	9.500	15.87	0.000	0.500
CERAMIC TILE FNSHER		BLD		34.810	0.000	2.0	1.5	2.0	10.20	7.830	0.000	0.640
COMMUNICATION TECH		BLD		36.440	40.080	1.5	1.5	2.0	10.39	12.09	0.000	0.760
ELECTRIC PWR EQMT OP		ALL		36.610	49.750	1.5	1.5	2.0	5.000	11.35	0.000	0.270
ELECTRIC PWR GRNDMAN		ALL		28.310	49.750	1.5	1.5	2.0	5.000	8.780	0.000	0.210
ELECTRIC PWR LINEMAN		ALL		43.830	49.750	1.5	1.5	2.0	5.000	13.58	0.000	0.330
ELECTRIC PWR TRK DRV		ALL		29.310	49.750	1.5	1.5	2.0	5.000	9.090	0.000	0.220
ELECTRICIAN		BLD		41.500	45.650	1.5	1.5	2.0	10.39	17.43	0.000	0.830
ELEVATOR CONSTRUCTOR		BLD		46.050	51.810	2.0	2.0	2.0	12.73	13.46	3.680	0.600
FENCE ERECTOR	SE	ALL		45.060	48.660	2.0	2.0	2.0	9.390	17.69	0.000	0.400
GLAZIER		BLD		35.730	37.730	1.5	1.5	2.0	9.950	8.200	0.000	1.250
HT/FROST INSULATOR		BLD		46.950	49.450	1.5	1.5	2.0	11.17	11.96	0.000	0.720
IRON WORKER	NW	ALL		35.090	36.840	2.0	2.0	2.0	8.340	22.19	0.000	0.500
IRON WORKER	SE	ALL		45.060	48.660	2.0	2.0	2.0	9.390	17.69	0.000	0.400
LABORER		BLD		30.570	31.820	1.5	1.5	2.0	8.240	12.95	0.000	0.800
LABORER		HWY		33.200	33.950	1.5	1.5	2.0	8.240	13.95	0.000	0.800
LABORER, SKILLED		HWY		35.650	36.400	1.5	1.5	2.0	8.240	13.95	0.000	0.800
LATHER		BLD		36.940	41.000	1.5	1.5	2.0	9.440	14.50	0.000	0.600
MACHINIST		BLD		43.920	46.420	1.5	1.5	2.0	6.760	8.950	1.850	0.000
MARBLE MASON		BLD		40.780	44.860	1.5	1.5	2.0	9.700	12.71	0.000	0.740
MATERIAL TESTER I		ALL		21.550	0.000	1.5	1.5	2.0	7.460	4.840	0.000	0.170
MATERIALS TESTER II		ALL		26.550	0.000	1.5	1.5	2.0	7.460	4.840	0.000	0.170
MILLWRIGHT		BLD		35.120	38.630	1.5	1.5	2.0	9.170	14.05	0.000	0.500
OPERATING ENGINEER		BLD	1	41.800	45.800	2.0	2.0	2.0	16.65	10.30	2.350	1.000
OPERATING ENGINEER		BLD	2	41.100	45.800	2.0	2.0	2.0	16.65	10.30	2.350	1.000
OPERATING ENGINEER		BLD	3	38.650	45.800	2.0	2.0	2.0	16.65	10.30	2.350	1.000
OPERATING ENGINEER		BLD	4	36.650	45.800	2.0	2.0	2.0	16.65	10.30	2.350	1.000
OPERATING ENGINEER		BLD	5	45.550	45.800	2.0	2.0	2.0	16.65	10.30	2.350	1.000
OPERATING ENGINEER		BLD	6	44.800	45.800	2.0	2.0	2.0	16.65	10.30	2.350	1.000
OPERATING ENGINEER		BLD	7	41.800	45.800	2.0	2.0	2.0	16.65	10.30	2.350	1.000
OPERATING ENGINEER		HWY	1	41.650	45.650	1.5	1.5	2.0	16.65	10.30	2.350	1.300
OPERATING ENGINEER		HWY	2	41.100	45.650	1.5	1.5	2.0	16.65	10.30	2.350	1.300
OPERATING ENGINEER		HWY	3	39.800	45.650	1.5	1.5	2.0	16.65	10.30	2.350	1.300
OPERATING ENGINEER		HWY	4	38.350	45.650	1.5	1.5	2.0	16.65	10.30	2.350	1.300
OPERATING ENGINEER		HWY	5	36.900	45.650	1.5	1.5	2.0	16.65	10.30	2.350	1.300
OPERATING ENGINEER		HWY	6	44.650	45.650	1.5	1.5	2.0	16.65	10.30	2.350	1.300
OPERATING ENGINEER		HWY	7	42.650	45.650	1.5	1.5	2.0	16.65	10.30	2.350	1.300
ORNAMNTL IRON WORKER	SE	ALL		45.060	48.660	2.0	2.0	2.0	9.390	17.69	0.000	0.400
PAINTER		ALL		40.980	42.980	1.5	1.5	1.5	10.00	8.200	0.000	1.350
PAINTER SIGNS		BLD		33.920	38.090	1.5	1.5	1.5	2.600	2.710	0.000	0.000
PILEDRIVER		BLD		37.440	41.560	1.5	1.5	2.0	9.440	14.50	0.000	0.600
PILEDRIVER		HWY		34.880	36.630	1.5	1.5	2.0	10.50	14.00	0.000	0.490
PIPEFITTER		BLD		41.200	43.200	1.5	1.5	2.0	9.750	17.59	0.000	1.710
PLASTERER		BLD		41.250	43.730	1.5	1.5	2.0	11.10	11.69	0.000	0.550
PLUMBER		BLD		41.200	43.200	1.5	1.5	2.0	9.750	17.59	0.000	1.710
ROOFER		BLD		39.200	42.200	1.5	1.5	2.0	8.280	9.690	0.000	0.430
SHEETMETAL WORKER		BLD		37.400	39.330	1.5	1.5	2.0	5.700	16.50	0.520	0.290
SPRINKLER FITTER		BLD		37.120	39.870	1.5	1.5	2.0	8.420	8.500	0.000	0.350
STEEL ERECTOR	SE	ALL		45.060	48.660	2.0	2.0	2.0	9.390	17.69	0.000	0.400

STONE MASON	BLD	41.580	45.740	1.5	1.5	2.0	9.700	12.80	0.000	1.040
SURVEY WORKER	ALL	35.650	36.400	1.5	1.5	2.0	8.240	13.95	0.000	0.800
TERRAZZO FINISHER	BLD	36.040	0.000	1.5	1.5	2.0	10.20	9.900	0.000	0.540
TERRAZZO MASON	BLD	39.880	42.880	1.5	1.5	2.0	10.20	11.25	0.000	0.700
TILE LAYER	BLD	36.940	41.000	1.5	1.5	2.0	9.440	14.50	0.000	0.600
TILE MASON	BLD	41.840	45.840	2.0	1.5	2.0	10.20	9.560	0.000	0.880
TRUCK DRIVER	ALL 1	32.550	33.100	1.5	1.5	2.0	6.500	4.350	0.000	0.000
TRUCK DRIVER	ALL 2	32.700	33.100	1.5	1.5	2.0	6.500	4.350	0.000	0.000
TRUCK DRIVER	ALL 3	32.900	33.100	1.5	1.5	2.0	6.500	4.350	0.000	0.000
TRUCK DRIVER	ALL 4	33.100	33.100	1.5	1.5	2.0	6.500	4.350	0.000	0.000
TUCKPOINTER	BLD	41.950	42.950	1.5	1.5	2.0	8.180	11.78	0.000	0.630

Legend:

RG (Region)
 TYP (Trade Type - All,Highway,Building,Floating,Oil & Chip,Rivers)
 C (Class)
 Base (Base Wage Rate)
 FRMAN (Foreman Rate)
 M-F>8 (OT required for any hour greater than 8 worked each day, Mon through Fri.
 OSA (Overtime (OT) is required for every hour worked on Saturday)
 OSH (Overtime is required for every hour worked on Sunday and Holidays)
 H/W (Health & Welfare Insurance)
 Pensn (Pension)
 Vac (Vacation)
 Trng (Training)

Explanations

DEKALB COUNTY

IRONWORKERS (NORTHWEST) - That portion of the county from a point where the western county line intersects with Rt. 30, continuing eastward to Shabbona, north between Shabbona and Clare, and northeast between Clare and New Lebanon.

The following list is considered as those days for which holiday rates of wages for work performed apply: New Years Day, Memorial Day, Fourth of July, Labor Day, Thanksgiving Day, Christmas Day and Veterans Day in some classifications/counties. Generally, any of these holidays which fall on a Sunday is celebrated on the following Monday. This then makes work performed on that Monday payable at the appropriate overtime rate for holiday pay. Common practice in a given local may alter certain days of celebration. If in doubt, please check with IDOL.

EXPLANATION OF CLASSES

ASBESTOS - GENERAL - removal of asbestos material/mold and hazardous materials from any place in a building, including mechanical systems where those mechanical systems are to be removed. This includes the removal of asbestos materials/mold and hazardous materials from ductwork or pipes in a building when the building is to be demolished at the time or at some close future date.

ASBESTOS - MECHANICAL - removal of asbestos material from mechanical systems, such as pipes, ducts, and boilers, where the mechanical systems are to remain.

CERAMIC TILE FINISHER

The grouting, cleaning, and polishing of all classes of tile, whether for interior or exterior purposes, all burned, glazed or unglazed

products; all composition materials, granite tiles, warning detectable tiles, cement tiles, epoxy composite materials, pavers, glass, mosaics, fiberglass, and all substitute materials, for tile made in tile-like units; all mixtures in tile like form of cement, metals, and other materials that are for and intended for use as a finished floor surface, stair treads, promenade roofs, walks, walls, ceilings, swimming pools, and all other places where tile is to form a finished interior or exterior. The mixing of all setting mortars including but not limited to thin-set mortars, epoxies, wall mud, and any other sand and cement mixtures or adhesives when used in the preparation, installation, repair, or maintenance of tile and/or similar materials. The handling and unloading of all sand, cement, lime, tile, fixtures, equipment, adhesives, or any other materials to be used in the preparation, installation, repair, or maintenance of tile and/or similar materials. Ceramic Tile Finishers shall fill all joints and voids regardless of method on all tile work, particularly and especially after installation of said tile work. Application of any and all protective coverings to all types of tile installations including, but not be limited to, all soap compounds, paper products, tapes, and all polyethylene coverings, plywood, masonite, cardboard, and any new type of products that may be used to protect tile installations, Blastrac equipment, and all floor scarifying equipment used in preparing floors to receive tile. The clean up and removal of all waste and materials. All demolition of existing tile floors and walls to be re-tiled.

COMMUNICATIONS TECHNICIAN

Installing, manufacturing, assembling and maintaining sound and intercom, protection alarm (security), fire alarm, master antenna television, closed circuit television, low voltage control for computers and/or door monitoring, school communications systems, telephones and servicing of nurse and emergency calls, and the installation and maintenance of transmit and receive antennas, transmitters, receivers, and associated apparatus which operates in conjunction with above systems. All work associated with these system installations will be included EXCEPT the installation of protective metallic conduit in new construction projects (excluding less than ten-foot, runs strictly for protection of cable) and 120 volt AC (or higher) power wiring and associated hardware.

LABORER, SKILLED - HIGHWAY

Individuals engaged in the following types of work, irrespective of the site of the work: asbestos abatement worker, handling of any materials with any foreign matter harmful to skin or clothing, track laborer, cement handlers, chloride handlers, the unloading and loading with steel workers and re-bars, concrete workers wet, tunnel helpers in free air, batch dumpers, mason tenders, kettle and tar men, tank cleaners, plastic installers, scaffold workers, motorized buggies or motorized unit used for wet concrete or handling of building materials, laborers with de-watering systems, sewer workers plus depth, rod and chainmen with technical engineers, rod and chainmen with land surveyors, rod and chainmen with surveyors, vibrator operators, cement silica, clay, fly ash, lime and plasters, handlers (bulk or bag), cofferdam workers plus depth, on concrete paving, placing, cutting and tying of reinforcing, deck hand, dredge hand, and shore laborers, bankmen on floating plant, grade checker, power tools, front end man on chip spreaders, cession workers plus depth, gunnite nozzle men, lead man on sewer work, welders, cutters, burners and torchmen, chainsaw operators, jackhammer and drill operators, layout man and/or drainage tile layer, steel form setter - street and

highway, air tamping hammermen, signal man on crane, concrete saw operator, screedman on asphalt pavers, laborers tending masons with hot material or where foreign materials are used, mortar mixer operators, multiple concrete duct - leadsman, lumen, asphalt raker, curb asphalt machine operator, ready mix scalemen (permanent, portable or temporary plant), laborers handling masterplate or similar materials, laser beam operator, concrete burning machine operator, coring machine operator, plaster tender, underpinning and shoring of buildings, pump men, manhole and catch basin, dirt and stone tamper, hose men on concrete pumps, hazardous waste worker, lead base paint abatement worker, lining of pipe, refusing machine, assisting on direct boring machine, the work of laying watermain, fire hydrants, all mechanical joints to watermain work, sewer worker, and tapping water service and forced lift station mechanical worker.

MATERIAL TESTER I: Hand coring and drilling for testing of materials; field inspection of uncured concrete and asphalt.

MATERIAL TESTER II: Field inspection of welds, structural steel, fireproofing, masonry, soil, facade, reinforcing steel, formwork, cured concrete, and concrete and asphalt batch plants; adjusting proportions of bituminous mixtures.

OPERATING ENGINEERS - BUILDING

Class 1. Asphalt Plant; Asphalt Spreader; Autograde; Backhoes with Caisson Attachment; Batch Plant; Benoto (requires Two Engineers); Boiler and Throttle Valve; Caisson Rigs; Central Redi-Mix Plant; Combination Back Hoe Front End-loader Machine; Compressor and Throttle Valve; Concrete Breaker (Truck Mounted); Concrete Conveyor; Concrete Paver (over 27E cu. ft.): Concrete Paver (27 cu. ft. and under); Concrete Placer; Concrete Pump (Truck Mounted); Concrete Conveyor (Truck Mounted); Concrete Tower; Cranes, All; GCI and similar types (required two operators only); Cranes, Hammerhead; Creter Crane; Crusher, Stone, etc.; Derricks, All; Derricks, Traveling; Formless Curb and Gutter Machine; Grader, Elevating; Grouting Machines; Highlift Shovels or Front Endloader 2-1/4 yd. and over; Hoists, Elevators, outside type rack and pinion and similar machines; Hoists, one, two and three Drum; Hoists, Two Tugger One Floor; Hydraulic Backhoes; Hydraulic Boom Trucks; Hydro Vac (and similar equipment - excluding hose work and any sewer work); Locomotives, All; Lubrication Technician; Manipulators; Motor Patrol; Pile Drivers and Skid Rig; Post Hole Digger; Pre-Stress Machine; Pump Cretes Dual Ram; Pump Cretes: Squeeze Cretes - Screw Type Pumps, Gypsum Bulker and Pump; Raised and Blind Hole Drill; Rock Drill (self-propelled); Rock Drill - Truck Mounted; Roto Mill Grinder; Scoops - Tractor Drawn; Slipform Paver; Scrapers Prime Movers; Straddle Buggies; Tie Back Machine; Tractor with Boom and Side Boom; Trenching Machines.

Class 2. Bobcat (over 3/4 cu. yd.); Boilers; Brick Forklift; Broom, All Power Propelled; Bulldozers; Concrete Mixer (Two Bag and Over); Conveyor, Portable; Forklift Trucks; Highlift Shovels or Front Endloaders under 2-1/4 yd.; Hoists, Automatic; Hoists, Sewer Dragging Machine; Hoists, Tugger Single Drum; Laser Screed; Rollers, All; Steam Generators; Tractors, All; Tractor Drawn Vibratory Roller; Winch Trucks with "A" Frame.

Class 3. Air Compressor; Asphalt Spreader; Combination - Small Equipment Operator; Generators; Heaters, Mechanical; Hoists, Inside Elevators - (Rheostat Manual Controlled); Hydraulic Power Units (Pile Driving, Extracting, or Drilling - with a seat); Lowboys; Pumps, Over 3" (1 to 3 not to exceed total of 300 ft.); Pumps, Well Points;

Welding Machines (2 through 5); Winches, 4 Small Electric Drill Winches; Bobcat (up to and including 3/4 cu. yd.).

Class 4. Elevator push button with automatic doors; Hoists, Inside; Oilers; Brick Forklift.

Class 5. Assistant Craft Foreman

Class 6. Mechanics; Welders.

Class 7. Gradall

OPERATING ENGINEERS - HIGHWAY CONSTRUCTION

Class 1. Asphalt Plant; Asphalt Heater and Planer Combination; Asphalt Heater Scarfire; Asphalt Silo Tender; Asphalt Spreader; Autograder; ABG Paver; Backhoes with Caisson Attachment; Ballast Regulator; Belt Loader; Caisson Rigs; Car Dumper; Central Redi-Mix Plant; Backhoe w/shear attachments; Combination Backhoe Front Endloader Machine, (1 cu. yd. Backhoe Bucket or over or with attachments); Concrete Breaker (Truck Mounted); Concrete Conveyor; Concrete Paver over 27E cu. ft.; Concrete Placer; Concrete Tube Float; Cranes, all attachments; Cranes, Tower of all types; Creter Crane; Crusher, Stone, etc.; Derricks, All; Derrick Boats; Derricks, Traveling; Directional Boring Machine over 12"; Dredges; Formless Curb and Gutter Machine; Grader, Elevating; Grader, Motor Grader, Motor Patrol, Auto Patrol, Form Grader, Pull Grader, Subgrader; Guard Rail Post Driver Mounted; Hoists, One, Two and Three Drum; Hydraulic Backhoes; Hydro Vac, Self Propelled, Truck Mounted (excluding hose work and any sewer work); Lubrication Technician; Manipulators; Pile Drivers and Skid Rig; Pre-Stress Machine; Pump Cretes Dual Ram; Rock Drill - Crawler or Skid Rig; Rock Drill - Truck Mounted; Rock/Track Tamper; Roto Mill Grinder; Slip-Form Paver; Snow Melters; Soil Test Drill Rig (Truck Mounted); Straddle Buggies; GCI Crane; Hydraulic Telescoping Form (Tunnel); Tie Back Machine; Tractor Drawn Belt Loader; Tractor Drawn Belt Loader with attached pusher; Tractor with Boom; Tractaire with Attachments; Traffic Barrier Conveyor Machine; Raised or Blind Hole Drills; Trenching Machine (over 12"); Truck Mounted Concrete Pump with Boom; Truck Mounted Concrete Conveyor; Work Boat (no license required - 90 h.p. or above); Underground Boring and/or Mining Machines; Wheel Excavator; Widener (APSCO).

Class 2. Batch Plant; Bituminous Mixer; Boiler and Throttle Valve; Bulldozers; Car Loader Trailing Conveyors; Combination Backhoe Front Endloader Machine (less than 1 cu. yd. Backhoe Bucket or over or with attachments); Compressor and Throttle Valve; Compressor, Common Receiver (3); Concrete Breaker or Hydro Hammer; Concrete Grinding Machine; Concrete Mixer or Paver 7S Series to and including 27 cu. ft.; Concrete Spreader; Concrete Curing Machine, Burlap Machine, Belting Machine and Sealing Machine; Concrete Wheel Saw (large self-propelled - excluding walk-behinds and hand-held); Conveyor Muck Cars (Haglund or Similar Type); Drills, all; Finishing Machine - Concrete; Highlift Shovels or Front Endloader; Hoist - Sewer Dragging Machine; Hydraulic Boom Trucks (All Attachments); Hydro Blaster; All Locomotives, Dinky; Off-Road Hauling Units; Non-Self Loading Dump; Ejection Dump; Pump Cretes: Squeeze Cretes - Screw Type Pumps, Gypsum Bulker and Pump; Roller, Asphalt; Rotary Snow Plows; Rototiller, Seaman, etc., self-propelled; Scoops - Tractor Drawn; Self-Propelled Compactor; Spreader - Chip - Stone, etc.; Scraper; Scraper - Prime Mover in Tandem (Regardless of Size); Tank Car Heater; Tractors, Push, Pulling Sheeps Foot, Disc, Compactor, etc.; Tug Boats.

Class 3. Boilers; Brooms, All Power Propelled; Cement Supply Tender; Compressor, Common Receiver (2); Concrete Mixer (Two Bag and Over); Conveyor, Portable; Farm-Type Tractors Used for Mowing, Seeding, etc.; Fireman on Boilers; Forklift Trucks; Grouting Machine; Hoists, Automatic; Hoists, All Elevators; Hoists, Tugger Single Drum; Jeep Diggers; Low Boys; Pipe Jacking Machines; Post-Hole Digger; Power Saw, Concrete Power Driven; Pug Mills; Rollers, other than asphalt; Seed and Straw Blower; Steam Generators; Stump Machine; Winch Trucks with "A" Frame; Work Boats; Tamper - Form - Motor Driven.

Class 4. Air Compressor - Small and Large; Asphalt Spreader, Backend Man; Bobcat (Skid Steer) all; Brick Forklift; Combination - Small Equipment Operator; Directional Boring Machine up to 12"; Generators; Heaters, Mechanical; Hydraulic Power Unit (Pile Driving, Extracting, or Drilling); Hydro-Blaster; Light Plants, All (1 through 5); Pumps, over 3" (1 to 3 not to exceed a total of 300 ft.); Pumps, Well Points; Tractaire; Trencher 12" and under; Welding Machines (2 through 5); Winches, 4 Small Electric Drill Winches.

Class 5. Oilers and Directional Boring Machine Locator.

Class 6. Field Mechanics and Field Welders

Class 7. Gradall and machines of like nature.

SURVEY WORKER - Operated survey equipment including data collectors, G.P.S. and robotic instruments, as well as conventional levels and transits.

TERRAZZO FINISHER

The handling of sand, cement, marble chips, and all other materials that may be used by the Mosaic Terrazzo Mechanic, and the mixing, grinding, grouting, cleaning and sealing of all Marble, Mosaic, and Terrazzo work, floors, base, stairs, and wainscoting by hand or machine, and in addition, assisting and aiding Marble, Masonic, and Terrazzo Mechanics.

TRUCK DRIVER - BUILDING, HEAVY AND HIGHWAY CONSTRUCTION

Class 1. Two or three Axle Trucks. A-frame Truck when used for transportation purposes; Air Compressors and Welding Machines, including those pulled by cars, pick-up trucks and tractors; Ambulances; Batch Gate Lockers; Batch Hopperman; Car and Truck Washers; Carry-alls; Fork Lifts and Hoisters; Helpers; Mechanics Helpers and Greasers; Oil Distributors 2-man operation; Pavement Breakers; Pole Trailer, up to 40 feet; Power Mower Tractors; Self-propelled Chip Spreader; Skipman; Slurry Trucks, 2-man operation; Slurry Truck Conveyor Operation, 2 or 3 man; Teamsters Unskilled dumpman; and Truck Drivers hauling warning lights, barricades, and portable toilets on the job site.

Class 2. Four axle trucks; Dump Crets and Adgetors under 7 yards; Dumpsters, Track Trucks, Euclids, Hug Bottom Dump Turnapulls or Turnatrailers when pulling other than self-loading equipment or similar equipment under 16 cubic yards; Mixer Trucks under 7 yards; Ready-mix Plant Hopper Operator, and Winch Trucks, 2 Axles.

Class 3. Five axle trucks; Dump Crets and Adgetors 7 yards and over; Dumpsters, Track Trucks, Euclids, Hug Bottom Dump Turnatrailers or turnapulls when pulling other than self-loading equipment or similar equipment over 16 cubic yards; Explosives and/or Fission Material

Trucks; Mixer Trucks 7 yards or over; Mobile Cranes while in transit; Oil Distributors, 1-man operation; Pole Trailer, over 40 feet; Pole and Expandable Trailers hauling material over 50 feet long; Slurry trucks, 1-man operation; Winch trucks, 3 axles or more; Mechanic--Truck Welder and Truck Painter.

Class 4. Six axle trucks; Dual-purpose vehicles, such as mounted crane trucks with hoist and accessories; Foreman; Master Mechanic; Self-loading equipment like P.B. and trucks with scoops on the front.

Other Classifications of Work:

For definitions of classifications not otherwise set out, the Department generally has on file such definitions which are available. If a task to be performed is not subject to one of the classifications of pay set out, the Department will upon being contacted state which neighboring county has such a classification and provide such rate, such rate being deemed to exist by reference in this document. If no neighboring county rate applies to the task, the Department shall undertake a special determination, such special determination being then deemed to have existed under this determination. If a project requires these, or any classification not listed, please contact IDOL at 217-782-1710 for wage rates or clarifications.

LANDSCAPING

Landscaping work falls under the existing classifications for laborer, operating engineer and truck driver. The work performed by landscape plantsman and landscape laborer is covered by the existing classification of laborer. The work performed by landscape operators (regardless of equipment used or its size) is covered by the classifications of operating engineer. The work performed by landscape truck drivers (regardless of size of truck driven) is covered by the classifications of truck driver.

BDE SPECIAL PROVISIONS
For the April 25 and June 13, 2014 Lettings

The following special provisions indicated by an "x" are applicable to this contract and will be included by the Project Development and Implementation Section of the BD&E. An * indicates a new or revised special provision for the letting.

<u>File Name</u>	<u>#</u>	<u>Special Provision Title</u>	<u>Effective</u>	<u>Revised</u>	
80240	1	Above Grade Inlet Protection	July 1, 2009	Jan. 1, 2012	
80099	2	Accessible Pedestrian Signals (APS)	April 1, 2003	Jan. 1, 2014	
80274	3	Aggregate Subgrade Improvement	April 1, 2012	Jan. 1, 2013	
80192	4	Automated Flagger Assistance Device	Jan. 1, 2008		
80173	5	Bituminous Materials Cost Adjustments	Nov. 2, 2006	Aug. 1, 2013	
80241	6	Bridge Demolition Debris	July 1, 2009		
50261	7	Building Removal-Case I (Non-Friable and Friable Asbestos)	Sept. 1, 1990	April 1, 2010	
50481	8	Building Removal-Case II (Non-Friable Asbestos)	Sept. 1, 1990	April 1, 2010	
50491	9	Building Removal-Case III (Friable Asbestos)	Sept. 1, 1990	April 1, 2010	
50531	10	Building Removal-Case IV (No Asbestos)	Sept. 1, 1990	April 1, 2010	
80292	11	Coarse Aggregate in Bridge Approach Slabs/Footings	April 1, 2012	April 1, 2013	
80310	12	Coated Galvanized Steel Conduit	Jan. 1, 2013		
80198	13	Completion Date (via calendar days)	April 1, 2008		
80199	14	Completion Date (via calendar days) Plus Working Days	April 1, 2008		
*	80293	15	Concrete Box Culverts with Skews > 30 Degrees and Design Fills ≤ 5 Feet	April 1, 2012	April 1, 2014
*	80294	16	Concrete Box Culverts with Skews ≤ 30 Degrees Regardless of Design Fill and Skews > 30 Degrees with Design Fills > 5 Feet	April 1, 2012	April 1, 2014
	80311	17	Concrete End Sections for Pipe Culverts	Jan. 1, 2013	
*	80334	18	Concrete Gutter, Curb, Median, and Paved Ditch	April 1, 2014	
	80277	19	Concrete Mix Design – Department Provided	Jan. 1, 2012	Jan. 1, 2014
	80261	20	Construction Air Quality – Diesel Retrofit	June 1, 2010	Jan. 1, 2014
*	80335	21	Contract Claims	April 1, 2014	
	80029	22	Disadvantaged Business Enterprise Participation	Sept. 1, 2000	Aug. 2, 2011
	80265	23	Friction Aggregate	Jan. 1, 2011	
	80229	24	Fuel Cost Adjustment	April 1, 2009	July 1, 2009
	80329	25	Glare Screen	Jan. 1, 2014	
	80303	26	Granular Materials	Nov. 1, 2012	
	80304	27	Grooving for Recessed Pavement Markings	Nov. 1, 2012	Jan. 1, 2013
	80246	28	Hot-Mix Asphalt – Density Testing of Longitudinal Joints	Jan. 1, 2010	April 1, 2012
	80322	29	Hot-Mix Asphalt – Mixture Design Composition and Volumetric Requirements	Nov. 1, 2013	
	80323	30	Hot-Mix Asphalt – Mixture Design Verification and Production	Nov. 1, 2013	
	80315	31	Insertion Lining of Culverts	Jan. 1, 2013	Nov. 1, 2013
*	80336	32	Longitudinal Joint and Crack Patching	April 1, 2014	
*	80324	33	LRFD Pipe Culvert Burial Tables	Nov. 1, 2013	April 1, 2014
	80325	34	LRFD Storm Sewer Burial Tables	Nov. 1, 2013	
	80045	35	Material Transfer Device	June 15, 1999	Jan. 1, 2009
	80165	36	Moisture Cured Urethane Paint System	Nov. 1, 2006	Jan. 1, 2010
*	80337	37	Paved Shoulder Removal	April 1, 2014	
	80330	38	Pavement Marking for Bike Symbol	Jan. 1, 2014	
	80298	39	Pavement Marking Tape Type IV	April 1, 2012	
	80254	40	Pavement Patching	Jan. 1, 2010	
	80331	41	Payrolls and Payroll Records	Jan. 1, 2014	
	80332	42	Portland Cement Concrete – Curing of Abutments and Piers	Jan. 1, 2014	
	80326	43	Portland Cement Concrete Equipment	Nov. 1, 2013	
*	80338	44	Portland Cement Concrete Partial Depth Hot-Mix Asphalt Patching	April 1, 2014	
	80300	45	Preformed Plastic Pavement Marking Type D - Inlaid	April 1, 2012	

<u>File Name</u>	<u>#</u>	<u>Special Provision Title</u>	<u>Effective</u>	<u>Revised</u>
80328	46	Progress Payments	Nov. 2, 2013	
80281	47	Quality Control/Quality Assurance of Concrete Mixtures	Jan. 1, 2012	Jan. 1, 2014
3426I	48	Railroad Protective Liability Insurance	Dec. 1, 1986	Jan. 1, 2006
80157	49	Railroad Protective Liability Insurance (5 and 10)	Jan. 1, 2006	
* 80306	50	Reclaimed Asphalt Pavement (RAP) and Reclaimed Asphalt Shingles (RAS)	Nov. 1, 2012	April 1, 2014
80327	51	Reinforcement Bars	Nov. 1, 2013	
80283	52	Removal and Disposal of Regulated Substances	Jan. 1, 2012	Nov. 2, 2012
80319	53	Removal and Disposal of Surplus Materials	Nov. 2, 2012	
80307	54	Seeding	Nov. 1, 2012	
* 80339	55	Stabilized Subbase	April 1, 2014	
80127	56	Steel Cost Adjustment	April 2, 2004	April 1, 2009
80317	57	Surface Testing of Hot-Mix Asphalt Overlays	Jan. 1, 2013	
80301	58	Tracking the Use of Pesticides	Aug. 1, 2012	
80333	59	Traffic Control Setup and Removal Freeway/Expressway	Jan. 1, 2014	
20338	60	Training Special Provisions	Oct. 15, 1975	
* 80318	61	Traversable Pipe Grate	Jan. 1, 2013	April 1, 2014
80288	62	Warm Mix Asphalt	Jan. 1, 2012	Nov. 1, 2013
80302	63	Weekly DBE Trucking Reports	June 2, 2012	
80289	64	Wet Reflective Thermoplastic Pavement Marking	Jan. 1, 2012	
80071	65	Working Days	Jan. 1, 2002	

The following special provisions are in the 2014 Supplemental Specifications and Recurring Special Provisions:

<u>File Name</u>	<u>Special Provision Title</u>	<u>New Location</u>	<u>Effective</u>	<u>Revised</u>
80309	Anchor Bolts	Articles 1006.09, 1070.01, and 1070.03	Jan. 1, 2013	
80276	Bridge Relief Joint Sealer	Article 503.19 and Sections 588 and 589	Jan. 1, 2012	Aug. 1, 2012
80312	Drain Pipe, Tile, Drainage Mat, and Wall Drain	Article 101.01, 1040.03, and 1040.04	Jan. 1, 2013	
80313	Fabric Bearing Pads	Article 1082.01	Jan. 1, 2013	
80169	High Tension Cable Median Barrier	Section 644 and Article 1106.02	Jan. 1, 2007	Jan. 1, 2013
80320	Liquidated Damages	Article 108.09	April 1, 2013	
80297	Modified Urethane Pavement Marking	Section 780, Articles 1095.09 and 1105.04	April 1, 2012	
80253	Movable Traffic Barrier	Section 707 and Article 1106.02	Jan. 1, 2010	Jan. 1, 2013
80231	Pavement Marking Removal	Recurring CS #33	April 1, 2009	
80321	Pavement Removal	Article 440.07	April 1, 2013	
80022	Payments to Subcontractors	Article 109.11	June 1, 2000	Jan. 1, 2006
80316	Placing and Consolidating Concrete	Articles 503.06, 503.07, and 516.12	Jan. 1, 2013	
80278	Planting Woody Plants	Section 253 and Article 1081.01	Jan. 1, 2012	Aug. 1, 2012
80305	Polyurea Pavement Markings	Article 780.14	Nov. 1, 2012	Jan. 1, 2013
80279	Portland Cement Concrete	Sections 312, 503, 1003, 1004, 1019, and 1020	Jan. 1, 2012	Nov. 1, 2013
80218	Preventive Maintenance – Bituminous Surface Treatment	Recurring CS #34	Jan. 1, 2009	April 1, 2012
80219	Preventive Maintenance – Cape Seal	Recurring CS #35	Jan. 1, 2009	April 1, 2012
80220	Preventive Maintenance – Micro-Surfacing	Recurring CS #36	Jan. 1, 2009	April 1, 2012
80221	Preventive Maintenance – Slurry Seal	Recurring CS #37	Jan. 1, 2009	April 1, 2012

<u>File Name</u>	<u>Special Provision Title</u>	<u>New Location</u>	<u>Effective</u>	<u>Revised</u>
80224	Restoring Bridge Approach Pavements Using High-Density Foam	Recurring CS #39	Jan. 1, 2009	Jan. 1, 2012
80255	Stone Matrix Asphalt	Sections 406, 1003, 1004, 1030, and 1011	Jan. 1, 2010	Aug. 1, 2013
80143	Subcontractor Mobilization Payments	Article 109.12	April 2, 2005	April 1, 2011
80308	Synthetic Fibers in Concrete Gutter, Curb, Median and Paved Ditch	Articles 606.02 and 606.11	Nov. 1, 2012	
80286	Temporary Erosion and Sediment Control	Articles 280.04 and 280.08	Jan. 1, 2012	
80225	Temporary Raised Pavement Marker	Recurring CS #38	Jan. 1, 2009	
80256	Temporary Water Filled Barrier	Section 708 and Article 1106.02	Jan. 1, 2010	Jan. 1, 2013
80273	Traffic Control Deficiency Deduction	Article 105.03	Aug. 1, 2011	
80270	Utility Coordination and Conflicts	Articles 105.07, 107.19, 107.31, 107.37, 107.38, 107.39 and 107.40	April 1, 2011	Jan. 1, 2012

The following special provisions require additional information from the designer. The additional information needs to be included in a separate document attached to this check sheet. The Project Development and Implementation section will then include the information in the applicable special provision. The Special Provisions are:

- Bridge Demolition Debris
- Building Removal-Case I
- Building Removal-Case II
- Building Removal-Case III
- Building Removal-Case IV
- Completion Date
- Completion Date Plus Working Days
- DBE Participation
- Material Transfer Device
- Railroad Protective Liability Insurance
- Training Special Provisions
- Working Days

FRICITION AGGREGATE (BDE)

Effective: January 1, 2011

Revise Article 1004.01(a)(4) of the Standard Specifications to read:

- “(4) Crushed Stone. Crushed stone shall be the angular fragments resulting from crushing undisturbed, consolidated deposits of rock by mechanical means. Crushed stone shall be divided into the following, when specified.
- a. Carbonate Crushed Stone. Carbonate crushed stone shall be either dolomite or limestone. Dolomite shall contain 11.0 percent or more magnesium oxide (MgO). Limestone shall contain less than 11.0 percent magnesium oxide (MgO).
 - b. Crystalline Crushed Stone. Crystalline crushed stone shall be either metamorphic or igneous stone, including but is not limited to, quartzite, granite, rhyolite and diabase.”

Revise Article 1004.03(a) of the Standard Specifications to read:

“1004.03 Coarse Aggregate for Hot-Mix Asphalt (HMA). The aggregate shall be according to Article 1004.01 and the following.

(a) Description. The coarse aggregate for HMA shall be according to the following table.

Use	Mixture	Aggregates Allowed
Class A	Seal or Cover	<u>Allowed Alone or in Combination:</u> Gravel Crushed Gravel Carbonate Crushed Stone Crystalline Crushed Stone Crushed Sandstone Crushed Slag (ACBF) Crushed Steel Slag Crushed Concrete
HMA All Other	Stabilized Subbase or Shoulders	<u>Allowed Alone or in Combination:</u> Gravel Crushed Gravel Carbonate Crushed Stone Crystalline Crushed Stone Crushed Sandstone Crushed Slag (ACBF) Crushed Steel Slag ^{1/} Crushed Concrete

Use	Mixture	Aggregates Allowed
HMA High ESAL Low ESAL	Binder IL-25.0, IL-19.0, or IL-19.0L SMA Binder	<u>Allowed Alone or in Combination:</u> Crushed Gravel Carbonate Crushed Stone ^{2/} Crystalline Crushed Stone Crushed Sandstone Crushed Slag (ACBF) Crushed Concrete ^{3/}
HMA High ESAL Low ESAL	C Surface and Leveling Binder IL-12.5,IL-9.5, or IL-9.5L SMA Ndesign 50 Surface	<u>Allowed Alone or in Combination:</u> Crushed Gravel Carbonate Crushed Stone ^{2/} Crystalline Crushed Stone Crushed Sandstone Crushed Slag (ACBF) Crushed Steel Slag ^{4/} Crushed Concrete ^{3/}
HMA High ESAL	D Surface and Leveling Binder IL-12.5 or IL-9.5 SMA Ndesign 50 Surface	<u>Allowed Alone or in Combination:</u> Crushed Gravel Carbonate Crushed Stone (other than Limestone) ^{2/} Crystalline Crushed Stone Crushed Sandstone Crushed Slag (ACBF) ^{5/} Crushed Steel Slag ^{4/ 5/} Crushed Concrete ^{3/}
		<u>Other Combinations Allowed:</u>
		<i>Up to...</i> <i>With...</i>
		25% Limestone Dolomite
		50% Limestone Any Mixture D aggregate other than Dolomite
		75% Limestone Crushed Slag (ACBF) ^{5/} or Crushed Sandstone

Use	Mixture	Aggregates Allowed	
HMA High ESAL	E Surface IL-12.5 or IL-9.5 SMA Ndesign 80 Surface	<u>Allowed Alone or in Combination:</u> Crushed Gravel Crystalline Crushed Stone Crushed Sandstone Crushed Slag (ACBF) ^{5/} Crushed Steel Slag ^{5/} Crushed Concrete ^{3/} No Limestone.	
		<u>Other Combinations Allowed:</u>	
		<i>Up to...</i>	<i>With...</i>
		50% Dolomite ^{2/}	Any Mixture E aggregate
		75% Dolomite ^{2/}	Crushed Sandstone, Crushed Slag (ACBF) ^{5/} , Crushed Steel Slag ^{5/} , or Crystalline Crushed Stone
HMA High ESAL	F Surface IL-12.5 or IL-9.5 SMA Ndesign 80 Surface	<u>Allowed Alone or in Combination:</u> Crystalline Crushed Stone Crushed Sandstone Crushed Slag (ACBF) ^{5/} Crushed Steel Slag ^{5/} No Limestone.	
		<u>Other Combinations Allowed:</u>	
<i>Up to...</i>	<i>With...</i>		

Use	Mixture	Aggregates Allowed	
		50% Crushed Gravel, Crushed Concrete ^{3/} , or Dolomite ^{2/}	Crushed Sandstone, Crushed Slag (ACBF) ^{5/} , Crushed Steel Slag ^{5/} , or Crystalline Crushed Stone

- 1/ Crushed steel slag allowed in shoulder surface only.
- 2/ Carbonate crushed stone shall not be used in SMA Ndesign 80. In SMA Ndesign 50, carbonate crushed stone shall not be blended with any of the other aggregates allowed alone in Ndesign 50 SMA binder or Ndesign 50 SMA surface.
- 3/ Crushed concrete will not be permitted in SMA mixes.
- 4/ Crushed steel slag shall not be used as leveling binder.
- 5/ When either slag is used, the blend percentages listed shall be by volume.”

80265

HOT-MIX ASPHALT - DENSITY TESTING OF LONGITUDINAL JOINTS (BDE)

Effective: January 1, 2010

Revised: April 1, 2012

Description. This work shall consist of testing the density of longitudinal joints as part of the quality control/quality assurance (QC/QA) of hot-mix asphalt (HMA). Work shall be according to Section 1030 of the Standard Specifications except as follows.

Quality Control/Quality Assurance (QC/QA). Delete the second and third sentence of the third paragraph of Article 1030.05(d)(3) of the Standard Specifications.

Add the following paragraphs to the end of Article 1030.05(d)(3) of the Standard Specifications:

“Longitudinal joint density testing shall be performed at each random density test location. Longitudinal joint testing shall be located at a distance equal to the lift thickness or a minimum of 4 in. (100 mm), from each pavement edge. (i.e. for a 5 in. (125 mm) lift the near edge of the density gauge or core barrel shall be within 5 in. (125 mm) from the edge of pavement.) Longitudinal joint density testing shall be performed using either a correlated nuclear gauge or cores.

- a. Confined Edge. Each confined edge density shall be represented by a one-minute nuclear density reading or a core density and shall be included in the average of density readings or core densities taken across the mat which represents the Individual Test.
- b. Unconfined Edge. Each unconfined edge joint density shall be represented by an average of three one-minute density readings or a single core density at the given density test location and shall meet the density requirements specified herein. The three one-minute readings shall be spaced ten feet apart longitudinally along the unconfined pavement edge and centered at the random density test location.”

Revise the Density Control Limits table in Article 1030.05(d)(4) of the Standard Specifications to read:

“Mixture Composition	Parameter	Individual Test (includes confined edges)	Unconfined Edge Joint Density Minimum
IL-4.75	Ndesign = 50	93.0 – 97.4%	91.0%
IL-9.5, IL-12.5	Ndesign ≥ 90	92.0 – 96.0%	90.0%
IL-9.5, IL-9.5L, IL-12.5	Ndesign < 90	92.5 – 97.4%	90.0%
IL-19.0, IL-25.0	Ndesign ≥ 90	93.0 – 96.0%	90.0%
IL-19.0, IL-19.0L, IL-25.0	Ndesign < 90	93.0 – 97.4%	90.0%

SMA	Ndesign = 50 & 80	93.5 – 97.4%	91.0%
All Other	Ndesign = 30	93.0 - 97.4%	90.0%”

80246

HOT-MIX ASPHALT – MIXTURE DESIGN COMPOSITION AND VOLUMETRIC REQUIREMENTS (BDE)

Effective: November 1, 2013

Revise Article 406.14(b) of the Standard Specifications to read.

“(b) If the HMA placed during the initial test strip (1) is determined to be unacceptable to remain in place by the Engineer, and (2) was not produced within 2.0 to 6.0 percent air voids or within the individual control limits of the JMF, the mixture and test strip will not be paid for and the mixture shall be removed at the Contractor’s expense. An additional test strip and mixture will be paid for in full, if produced within 2.0 to 6.0 percent air voids and within the individual control limits of the JMF.”

Revise Article 406.14(c) of the Standard Specifications to read.

“(c) If the HMA placed during the initial test strip (1) is determined to be unacceptable to remain in place by the Engineer, and (2) was produced within 2.0 to 6.0 percent air voids and within the individual control limits of the JMF, the mixture shall be removed. Removal will be paid in accordance to Article 109.04. This initial mixture and test strip will be paid for at the contract unit prices. The additional mixture will be paid for at the contract unit price, and any additional test strips will be paid for at one half the unit price of each test strip.”

Revise Article 1030.04(a)(1) of the Standard Specifications to read.

“(1) High ESAL Mixtures. The Job Mix Formula (JMF) shall fall within the following limits.

High ESAL, MIXTURE COMPOSITION (% PASSING) ^{1/}										
Sieve Size	IL-25.0 mm		IL-19.0 mm		IL-12.5 mm		IL-9.5 mm		IL-4.75 mm	
	min	max	min	max	min	max	min	max	min	max
1 1/2 in. (37.5 mm)		100								
1 in. (25 mm)	90	100		100						
3/4 in. (19 mm)		90	82	100		100				
1/2 in. (12.5 mm)	45	75	50	85	90	100		100		100
3/8 in. (9.5 mm)						89	90	100		100
#4 (4.75 mm)	24	42 ^{2/}	24	50 ^{2/}	28	65	32	69	90	100
#8 (2.36 mm)	16	31	20	36	28	48 ^{3/}	32	52 ^{3/}	70	90
#16 (1.18 mm)	10	22	10	25	10	32	10	32	50	65
#50 (300 µm)	4	12	4	12	4	15	4	15	15	30
#100 (150 µm)	3	9	3	9	3	10	3	10	10	18
#200 (75 µm)	3	6	3	6	4	6	4	6	7	9

Ratio Dust/Asphalt Binder		1.0		1.0		1.0		1.0		1.0 ^{1/4}
---------------------------------	--	-----	--	-----	--	-----	--	-----	--	--------------------

- 1/ Based on percent of total aggregate weight.
- 2/ The mixture composition shall not exceed 40 percent passing the #4 (4.75 mm) sieve for binder courses with Ndesign ≥ 90.
- 3/ The mixture composition shall not exceed 44 percent passing the #8 (2.36 mm) sieve for surface courses with Ndesign ≥ 90.
- 4/ Additional minus No. 200 (0.075 mm) material required by the mix design shall be mineral filler, unless otherwise approved by the Engineer.”

Delete Article 1030.04(a)(4) of the Standard Specifications.

Revise Article 1030.04(b)(1) of the Standard Specifications to read.

“(1) High ESAL Mixtures. The target value for the air voids of the HMA shall be 4.0 percent at the design number of gyrations. The VMA and VFA of the HMA design shall be based on the nominal maximum size of the aggregate in the mix, and shall conform to the following requirements.

VOLUMETRIC REQUIREMENTS High ESAL						
Ndesign	Voids in the Mineral Aggregate (VMA), % minimum					Voids Filled with Asphalt Binder (VFA), %
	IL-25.0	IL-19.0	IL-12.5	IL-9.5	IL-4.75 ^{1/}	
50	12.0	13.0	14.0	15.0	18.5	65 – 78 ^{2/}
70					65 - 75	
90						
105						

- 1/ Maximum Draindown for IL-4.75 shall be 0.3 percent
- 2/ VFA for IL-4.75 shall be 76-83 percent”

Delete Article 1030.04(b)(4) of the Standard Specifications.

Revise the Control Limits Table in Article 1030.05(d)(4) of the Standard Specifications to read.

“CONTROL LIMITS

Parameter	High ESAL Low ESAL	High ESAL Low ESAL	All Other	IL-4.75	IL-4.75
	Individual Test	Moving Avg. of 4	Individual Test	Individual Test	Moving Avg. of 4
% Passing: ^{1/}					
1/2 in. (12.5 mm)	± 6 %	± 4 %	± 15 %		
No. 4 (4.75 mm)	± 5 %	± 4 %	± 10 %		
No. 8 (2.36 mm)	± 5 %	± 3 %			
No. 16 (1.18 mm)				± 4 %	± 3 %
No. 30 (600 µm)	± 4 %	± 2.5 %			
Total Dust Content No. 200 (75 µm)	± 1.5 %	± 1.0 %	± 2.5 %	± 1.5 %	± 1.0 %
Asphalt Binder Content	± 0.3 %	± 0.2 %	± 0.5 %	± 0.3 %	± 0.2 %
Voids	± 1.2 %	± 1.0 %	± 1.2 %	± 1.2 %	± 1.0 %
VMA	-0.7 % ^{2/}	-0.5 % ^{2/}		-0.7 % ^{2/}	-0.5 % ^{2/}

1/ Based on washed ignition oven

2/ Allowable limit below minimum design VMA requirement"

HOT-MIX ASPHALT – MIXTURE DESIGN VERIFICATION AND PRODUCTION (BDE)

Effective: November 1, 2013

Description. This special provision provides the requirements for Hamburg Wheel and tensile strength testing for High ESAL, IL-4.75, and Stone Matrix Asphalt (SMA) hot-mix asphalt (HMA) mixes during mix design verification and production. This special provision also provides the plant requirements for hydrated lime addition systems used in the production of High ESAL, IL-4.75, and SMA mixes.

Mix Design Testing. Add the following to Article 1030.04 of the Standard Specifications:

“(d) Verification Testing. High ESAL, IL-4.75, and SMA mix designs submitted for verification will be tested to ensure that the resulting mix designs will pass the required criteria for the Hamburg Wheel Test (Illinois Modified AASHTO T 324) and the Tensile Strength Test (Illinois Modified AASHTO T 283). The Department will perform a verification test on gyratory specimens compacted by the Contractor. If the mix fails the Department’s verification test, the Contractor shall make necessary changes to the mix and provide passing Hamburg Wheel and tensile strength test results from a private lab. The Department will verify the passing results.

All new and renewal mix designs shall meet the following requirements for verification testing.

(1) Hamburg Wheel Test Criteria. The maximum allowable rut depth shall be 0.5 in. (12.5 mm). The minimum number of wheel passes at the 0.5 in. (12.5 mm) rut depth criteria shall be based on the high temperature binder grade of the mix as specified in the mix requirements table of the plans.

Illinois Modified AASHTO T 324 Requirements ^{1/}

PG Grade	Number of Passes
PG 58-xx (or lower)	5,000
PG 64-xx	7,500
PG 70-xx	15,000
PG 76-xx (or higher)	20,000

1/ When produced at temperatures of 275 ± 5 °F (135 ± 3 °C) or less, loose Warm Mix Asphalt shall be oven aged at 270 ± 5 °F (132 ± 3 °C) for two hours prior to gyratory compaction of Hamburg Wheel specimens.

(2) Tensile Strength Criteria. The minimum allowable conditioned tensile strength shall be 415 kPa (60 psi) for non-polymer modified performance graded (PG) asphalt binder and 550 kPa (80 psi) for polymer modified PG asphalt binder. The maximum allowable unconditioned tensile strength shall be 1380 kPa (200 psi).”

Production Testing. Revise Article 1030.06(a) of the Standard Specifications to read:

“(a) High ESAL, IL-4.75 and SMA Mixtures. For each contract, a 300 ton (275 metric tons) test strip will be required at the beginning of HMA production for each mixture with a quantity of 3000 tons (2750 metric tons) or more according to the Manual of Test Procedures for Materials “Hot Mix Asphalt Test Strip Procedures”.

Before start-up, target values shall be determined by applying gradation correction factors to the JMF when applicable. These correction factors shall be determined from previous experience. The target values, when approved by the Engineer, shall be used to control HMA production. Plant settings and control charts shall be set according to target values.

Before constructing the test strip, target values shall be determined by applying gradation correction factors to the JMF when applicable. After any JMF adjustment, the JMF shall become the Adjusted Job Mix Formula (AJMF). Upon completion of the first acceptable test strip, the JMF shall become the AJMF regardless of whether or not the JMF has been adjusted. If an adjustment/plant change is made, the Engineer may require a new test strip to be constructed. If the HMA placed during the initial test strip is determined to be unacceptable to remain in place by the Engineer, it shall be removed and replaced.

The limitations between the JMF and AJMF are as follows.

Parameter	Adjustment
1/2 in. (12.5 mm)	± 5.0 %
No. 4 (4.75 mm)	± 4.0 %
No. 8 (2.36 mm)	± 3.0 %
No. 30 (600 µm)	*
No. 200 (75 µm)	*
Asphalt Binder Content	± 0.3 %

* In no case shall the target for the amount passing be greater than the JMF.

Any adjustments outside the above limitations will require a new mix design.

Mixture sampled to represent the test strip shall include additional material sufficient for the Department to conduct Hamburg Wheel testing according to Illinois Modified AASHTO T324 (approximately 60 lb (27 kg) total).

The Contractor shall immediately cease production upon notification by the Engineer of failing Hamburg Wheel test. All prior produced material may be paved out provided all other mixture criteria is being met. No additional mixture shall be produced until the Engineer receives passing Hamburg Wheel tests.

The Department may conduct additional Hamburg Wheel tests on production material as determined by the Engineer.”

Revise the title of Article 1030.06(b) of the Standard Specifications to read:

“(b) Low ESAL and All Other Mixtures.”

System for Hydrated Lime Addition. Revise the fourth sentence of the third paragraph of Article 1030.04(c) of the Standard Specifications to read:

“The method of application shall be according to Article 1102.01(a)(10).”

Replace the first three sentences of the second paragraph of Article 1102.01(a)(10) of the Standard Specifications to read:

“When hydrated lime is used as the anti-strip additive, a separate bin or tank and feeder system shall be provided to store and accurately proportion the lime onto the aggregate either as a slurry, as dry lime applied to damp aggregates, or as dry lime injected onto the hot aggregates prior to adding the liquid asphalt cement. If the hydrated lime is added either as a slurry or as dry lime on damp aggregates, the lime and aggregates shall be mixed by a power driven pugmill to provide a uniform coating of the lime prior to entering the dryer. If dry hydrated lime is added to the hot dry aggregates in a dryer-drum plant, the lime shall be added in such a manner that the lime will not become entrained into the air stream of the dryer-drum and that thorough dry mixing shall occur prior to the injection point of the liquid asphalt. When a batch plant is used, the hydrated lime shall be added to the mixture in the weigh hopper or as approved by the Engineer.”

Basis of Payment. Replace the seventh paragraph of Article 406.14 of the Standard Specifications with the following:

“For mixes designed and verified under the Hamburg Wheel criteria, the cost of furnishing and introducing anti-stripping additives in the HMA will not be paid for separately, but shall be considered as included in the contract unit price of the HMA item involved.

If an anti-stripping additive is required for any other HMA mix, the cost of the additive will be paid for according to Article 109.04. The cost incurred in introducing the additive into the HMA will not be paid for separately, but shall be considered as included in the contract unit price of the HMA item involved.

No additional compensation will be awarded to the Contractor because of reduced production rates associated with the addition of the anti-stripping additive.”

RECLAIMED ASPHALT PAVEMENT AND RECLAIMED ASPHALT SHINGLES (BDE)

Effective: November 1, 2012

Revise: January 1, 2013

Revise Section 1031 of the Standard Specifications to read:

“SECTION 1031. RECLAIMED ASPHALT PAVEMENT AND RECLAIMED ASPHALT SHINGLES

1031.01 Description. Reclaimed asphalt pavement and reclaimed asphalt shingles shall be according to the following.

- (a) Reclaimed Asphalt Pavement (RAP). RAP is the material produced by cold milling or crushing an existing hot-mix asphalt (HMA) pavement. The Contractor shall supply written documentation that the RAP originated from routes or airfields under federal, state, or local agency jurisdiction.
- (b) Reclaimed Asphalt Shingles (RAS). Reclaimed asphalt shingles (RAS). RAS is from the processing and grinding of preconsumer or post-consumer shingles. RAS shall be a clean and uniform material with a maximum of 0.5 percent unacceptable material, as defined in Bureau of Materials and Physical Research Policy Memorandum “Reclaimed Asphalt Shingle (RAS) Sources”, by weight of RAS. All RAS used shall come from a Bureau of Materials and Physical Research approved processing facility where it shall be ground and processed to 100 percent passing the 3/8 in. (9.5 mm) sieve and 93 percent passing the #4 (4.75 mm) sieve based on a dry shake gradation. RAS shall be uniform in gradation and asphalt binder content and shall meet the testing requirements specified herein. In addition, RAS shall meet the following Type 1 or Type 2 requirements.
 - (1) Type 1. Type 1 RAS shall be processed, preconsumer asphalt shingles salvaged from the manufacture of residential asphalt roofing shingles.
 - (2) Type 2. Type 2 RAS shall be processed post-consumer shingles only, salvaged from residential, or four unit or less dwellings not subject to the National Emission Standards for Hazardous Air Pollutants (NESHAP).

1031.02 Stockpiles. RAP and RAS stockpiles shall be according to the following.

- (a) RAP Stockpiles. The Contractor shall construct individual, sealed RAP stockpiles meeting one of the following definitions. No additional RAP shall be added to the pile after the pile has been sealed. Stockpiles shall be sufficiently separated to prevent intermingling at the base. Stockpiles shall be identified by signs indicating the type as listed below (i.e. “Homogeneous Surface”).

Prior to milling, the Contractor shall request the District provide documentation on the quality of the RAP to clarify the appropriate stockpile.

- (1) Fractionated RAP (FRAP). FRAP shall consist of RAP from Class I, HMA (High and Low ESAL) mixtures. The coarse aggregate in FRAP shall be crushed aggregate and may represent more than one aggregate type and/or quality but shall be at least C quality. All FRAP shall be fractionated prior to testing by screening into a minimum of two size fractions with the separation occurring on or between the #4 (4.75 mm) and 1/2 in. (12.5 mm) sieves. Agglomerations shall be minimized such that 100 percent of the RAP shall pass the sieve size specified below for the mix the FRAP will be incorporated.

Mixture FRAP will be used in:	Sieve Size that 100% of FRAP Shall Pass
IL-25.0	2 in. (50 mm)
IL-19.0	1 1/2 in. (40 mm)
IL-12.5	1 in. (25 mm)
IL-9.5	3/4 in. (20 mm)
IL-4.75	1/2 in. (13 mm)

- (2) Homogeneous. Homogeneous RAP stockpiles shall consist of RAP from Class I, HMA (High and Low ESAL) mixtures and represent: 1) the same aggregate quality, but shall be at least C quality; 2) the same type of crushed aggregate (either crushed natural aggregate, ACBF slag, or steel slag); 3) similar gradation; and 4) similar asphalt binder content. If approved by the Engineer, combined single pass surface/binder millings may be considered "homogenous" with a quality rating dictated by the lowest coarse aggregate quality present in the mixture.
- (3) Conglomerate. Conglomerate RAP stockpiles shall consist of RAP from Class I, HMA (High and Low ESAL) mixtures. The coarse aggregate in this RAP shall be crushed aggregate and may represent more than one aggregate type and/or quality but shall be at least C quality. This RAP may have an inconsistent gradation and/or asphalt binder content prior to processing. All conglomerate RAP shall be processed prior to testing by crushing to where all RAP shall pass the 5/8 in. (16 mm) or smaller screen. Conglomerate RAP stockpiles shall not contain steel slag.
- (4) Conglomerate "D" Quality (DQ). Conglomerate DQ RAP stockpiles shall consist of RAP from Class I, HMA (High or Low ESAL), or "All Other" (as defined by Article 1030.04(a)(3)) mixtures. The coarse aggregate in this RAP may be crushed or round but shall be at least D quality. This RAP may have an inconsistent gradation and/or asphalt binder content. Conglomerate DQ RAP stockpiles shall not contain steel slag.
- (5) Non-Quality. RAP stockpiles that do not meet the requirements of the stockpile categories listed above shall be classified as "Non-Quality".

RAP/FRAP containing contaminants, such as earth, brick, sand, concrete, sheet asphalt, bituminous surface treatment (i.e. chip seal), pavement fabric, joint sealants, etc., will be unacceptable unless the contaminants are removed to the satisfaction of the Engineer. Sheet asphalt shall be stockpiled separately.

- (b) RAS Stockpiles. Type 1 and Type 2 RAS shall be stockpiled separately and shall not be intermingled. Each stockpile shall be signed indicating what type of RAS is present.

Unless otherwise approved by the Engineer, mechanically blending manufactured sand (FM 20 or FM 22) up to an equal weight of RAS with the processed RAS will be permitted to improve workability. The sand shall be "B Quality" or better from an approved Aggregate Gradation Control System source. The sand shall be accounted for in the mix design and during HMA production.

Records identifying the shingle processing facility supplying the RAS, RAS type and lot number shall be maintained by project contract number and kept for a minimum of three years.

1031.03 Testing. RAP/FRAP and RAS testing shall be according to the following.

- (a) RAP/FRAP Testing. When used in HMA, the RAP/FRAP shall be sampled and tested either during or after stockpiling.

- (1) During Stockpiling. For testing during stockpiling, washed extraction samples shall be run at the minimum frequency of one sample per 500 tons (450 metric tons) for the first 2000 tons (1800 metric tons) and one sample per 2000 tons (1800 metric tons) thereafter. A minimum of five tests shall be required for stockpiles less than 4000 tons (3600 metric tons).

- (2) After Stockpiling. For testing after stockpiling, the Contractor shall submit a plan for approval to the District proposing a satisfactory method of sampling and testing the RAP/FRAP pile either in-situ or by restockpiling. The sampling plan shall meet the minimum frequency required above and detail the procedure used to obtain representative samples throughout the pile for testing.

Each sample shall be split to obtain two equal samples of test sample size. One of the two test samples from the final split shall be labeled and stored for Department use. The Contractor shall extract the other test sample according to Department procedure. The Engineer reserves the right to test any sample (split or Department-taken) to verify Contractor test results.

- (b) RAS Testing. RAS or RAS blended with manufactured sand shall be sampled and tested during stockpiling according to Illinois Department of Transportation Policy Memorandum, "Reclaimed Asphalt Shingle (RAS) Source".

Samples shall be collected during stockpiling at the minimum frequency of one sample per 200 tons (180 metric tons) for the first 1000 tons (900 metric tons) and one sample per 250 tons (225 metric tons) thereafter. A minimum of five samples are required for stockpiles less than 1000 tons (900 metric tons). Once a ≤ 1000 ton (900 metric ton), five-sample/test stockpile has been established it shall be sealed. Additional incoming RAS or RAS blended with manufactured sand shall be stockpiled in a separate working pile as designated in the Quality Control plan and only added to the sealed stockpile when the test results of the working pile are complete and are found to meet the tolerances specified herein for the original sealed RAS stockpile.

Before testing, each sample shall be split to obtain two test samples. One of the two test samples from the final split shall be labeled and stored for Department use. The Contractor shall perform a washed extraction and test for unacceptable materials on the other test sample according to Department procedures. The Engineer reserves the right to test any sample (split or Department-taken) to verify Contractor test results.

If the sampling and testing was performed at the shingle processing facility in accordance with the QC Plan, the Contractor shall obtain and make available all of the test results from start of the initial stockpile.

1031.04 Evaluation of Tests. Evaluation of tests results shall be according to the following.

- (a) Evaluation of RAP/FRAP Test Results. All of the extraction results shall be compiled and averaged for asphalt binder content and gradation and, when applicable G_{mm} . Individual extraction test results, when compared to the averages, will be accepted if within the tolerances listed below.

Parameter	FRAP/Homogeneous /Conglomerate	Conglomerate "D" Quality
1 in. (25 mm)		$\pm 5 \%$
1/2 in. (12.5 mm)	$\pm 8 \%$	$\pm 15 \%$
No. 4 (4.75 mm)	$\pm 6 \%$	$\pm 13 \%$
No. 8 (2.36 mm)	$\pm 5 \%$	
No. 16 (1.18 mm)		$\pm 15 \%$
No. 30 (600 μm)	$\pm 5 \%$	
No. 200 (75 μm)	$\pm 2.0 \%$	$\pm 4.0 \%$
Asphalt Binder	$\pm 0.4 \%$ ^{1/}	$\pm 0.5 \%$
G_{mm}	± 0.03	

1/ The tolerance for FRAP shall be $\pm 0.3 \%$.

If more than 20 percent of the individual sieves and/or asphalt binder content tests are out of the above tolerances, the RAP/FRAP shall not be used in HMA unless the

RAP/FRAP representing the failing tests is removed from the stockpile. All test data and acceptance ranges shall be sent to the District for evaluation.

With the approval of the Engineer, the ignition oven may be substituted for extractions according to the Illinois Test Procedure, "Calibration of the Ignition Oven for the Purpose of Characterizing Reclaimed Asphalt Pavement (RAP)".

- (b) Evaluation of RAS and RAS Blended with Manufactured Sand Test Results. All of the test results, with the exception of percent unacceptable materials, shall be compiled and averaged for asphalt binder content and gradation. Individual test results, when compared to the averages, will be accepted if within the tolerances listed below.

Parameter	RAS
No. 8 (2.36 mm)	± 5 %
No. 16 (1.18 mm)	± 5 %
No. 30 (600 µm)	± 4 %
No. 200 (75 µm)	± 2.0 %
Asphalt Binder Content	± 1.5 %

If more than 20 percent of the individual sieves and/or asphalt binder content tests are out of the above tolerances, or if the percent unacceptable material exceeds 0.5 percent by weight of material retained on the # 4 (4.75 mm) sieve, the RAS or RAS blend shall not be used in Department projects. All test data and acceptance ranges shall be sent to the District for evaluation.

1031.05 Quality Designation of Aggregate in RAP/FRAP.

- (a) RAP. The aggregate quality of the RAP for homogenous, conglomerate, and conglomerate "D" quality stockpiles shall be set by the lowest quality of coarse aggregate in the RAP stockpile and are designated as follows.
- (1) RAP from Class I, Superpave/HMA (High ESAL), or (Low ESAL) IL-9.5L surface mixtures are designated as containing Class B quality coarse aggregate.
 - (2) RAP from Superpave/HMA (Low ESAL) IL-19.0L binder mixture is designated as Class D quality coarse aggregate.
 - (3) RAP from Class I, Superpave/HMA (High ESAL) binder mixtures, bituminous base course mixtures, and bituminous base course widening mixtures are designated as containing Class C quality coarse aggregate.
 - (4) RAP from bituminous stabilized subbase and BAM shoulders are designated as containing Class D quality coarse aggregate.
- (b) FRAP. If the Engineer has documentation of the quality of the FRAP aggregate, the Contractor shall use the assigned quality provided by the Engineer.

If the quality is not known, the quality shall be determined as follows. Coarse and fine FRAP stockpiles containing plus #4 (4.75 mm) sieve coarse aggregate shall have a maximum tonnage of 5,000 tons (4,500 metric tons). The Contractor shall obtain a representative sample witnessed by the Engineer. The sample shall be a minimum of 50 lb (25 kg). The sample shall be extracted according to Illinois Modified AASHTO T 164 by a consultant prequalified by the Department for the specified testing. The consultant shall submit the test results along with the recovered aggregate to the District Office. The cost for this testing shall be paid by the Contractor. The District will forward the sample to the BMPR Aggregate Lab for MicroDeval Testing, according to Illinois Modified AASHTO T 327. A maximum loss of 15.0 percent will be applied for all HMA applications.

1031.06 Use of RAP/FRAP and/or RAS in HMA. The use of RAP/FRAP and/or RAS shall be a Contractor's option when constructing HMA in all contracts.

(a) RAP/FRAP. The use of RAP/FRAP in HMA shall be as follows.

- (1) Coarse Aggregate Size. The coarse aggregate in all RAP shall be equal to or less than the nominal maximum size requirement for the HMA mixture to be produced.
- (2) Steel Slag Stockpiles. Homogeneous RAP stockpiles containing steel slag will be approved for use in all HMA (High ESAL and Low ESAL) Surface and Binder Mixture applications.
- (3) Use in HMA Surface Mixtures (High and Low ESAL). RAP/FRAP stockpiles for use in HMA surface mixtures (High and Low ESAL) shall be FRAP or homogeneous in which the coarse aggregate is Class B quality or better. RAP/FRAP from Conglomerate stockpiles shall be considered equivalent to limestone for frictional considerations. Known frictional contributions from plus #4 (4.75 mm) homogeneous RAP and FRAP stockpiles will be accounted for in meeting frictional requirements in the specified mixture.
- (4) Use in HMA Binder Mixtures (High and Low ESAL), HMA Base Course, and HMA Base Course Widening. RAP/FRAP stockpiles for use in HMA binder mixtures (High and Low ESAL), HMA base course, and HMA base course widening shall be FRAP, homogeneous, or conglomerate, in which the coarse aggregate is Class C quality or better.
- (5) Use in Shoulders and Subbase. RAP/FRAP stockpiles for use in HMA shoulders and stabilized subbase (HMA) shall be FRAP, homogeneous, conglomerate, or conglomerate DQ.
- (6) When the Contractor chooses the RAP option, the percentage of RAP shall not exceed the amounts indicated in Article 1031.06(c)(1) below for a given N Design.

- (b) RAS. RAS meeting Type 1 or Type 2 requirements will be permitted in all HMA applications as specified herein.
- (c) RAP/FRAP and/or RAS Usage Limits. Type 1 or Type 2 RAS may be used alone or in conjunction with RAP or FRAP in HMA mixtures up to a maximum of 5.0% by weight of the total mix.
- (1) RAP/RAS. When RAP is used alone or RAP is used in conjunction with RAS, the percentage of virgin asphalt binder replacement shall not exceed the amounts listed in the Max RAP/RAS ABR table listed below for the given Ndesign.

RAP/RAS Maximum Asphalt Binder Replacement (ABR) Percentage

HMA Mixtures ^{1/, 2/}	RAP/RAS Maximum ABR %		
Ndesign	Binder/Leveling Binder	Surface	Polymer Modified
30	30	30	10
50	25	15	10
70	15	10	10
90	10	10	10
105	10	10	10

1/ For HMA “All Other” (shoulder and stabilized subbase) N-30, the RAP/RAS ABR shall not exceed 50 percent of the mixture.

2/ When RAP/RAS ABR exceeds 20 percent, the high and low virgin asphalt binder grades shall each be reduced by one grade (i.e. 25 percent ABR would require a virgin asphalt binder grade of PG64-22 to be reduced to a PG58-28). If warm mix asphalt (WMA) technology is utilized, and production temperatures do not exceed 275 °F (135 °C) the high and low virgin asphalt binder grades shall each be reduced by one grade when RAP/RAS ABR exceeds 25 percent (i.e. 26 percent RAP/RAS ABR would require a virgin asphalt binder grade of PG64-22 to be reduced to a PG58-28).

(2) FRAP/RAS. When FRAP is used alone or FRAP is used in conjunction with RAS, the percentage of virgin asphalt binder replacement shall not exceed the amounts listed in the FRAP/RAS tables listed below for the given N design.

Level 1 - FRAP/RAS Maximum Asphalt Binder Replacement (ABR) Percentage

HMA Mixtures ^{1/, 2/}	Level 1 - FRAP/RAS Maximum ABR %		
Ndesign	Binder/Leveling Binder	Surface	Polymer Modified ^{3/, 4/}
30	35	35	10

50	30	25	10
70	25	20	10
90	20	15	10
105	10	10	10

- 1/ For HMA “All Other” (shoulder and stabilized subbase) N30, the FRAP/RAS ABR shall not exceed 50 percent of the mixture.
- 2/ When FRAP/RAS ABR exceeds 20 percent for all mixes the high and low virgin asphalt binder grades shall each be reduced by one grade (i.e. 25 percent ABR would require a virgin asphalt binder grade of PG64-22 to be reduced to a PG58-28). If warm mix asphalt (WMA) technology is utilized, and production temperatures do not exceed 275 °F (135 °C) the high and low virgin asphalt binder grades shall each be reduced by one grade when FRAP/RAS ABR exceeds 25 percent (i.e. 26 percent ABR would require a virgin asphalt binder grade of PG64-22 to be reduced to a PG58-28).
- 3/ For SMA the FRAP/RAS ABR shall not exceed 20 percent.
- 4/ For IL-4.75 mix the FRAP/RAS ABR shall not exceed 20 percent.

Level 2 – FRAP/RAS Maximum Asphalt Binder Replacement (ABR) Percentage

HMA Mixtures <small>1/, 2/</small>	Level 2 – FRAP/RAS Maximum ABR %		
	Ndesign	Binder/Leveling Binder	Surface
30	40	40	10
50	40	30	10
70	30	20	10
90	30	20	10
105	30	15	10

- 1/ For HMA “All Other” (shoulder and stabilized subbase) N30, the FRAP/RAS ABR shall not exceed 50 percent of the mixture.
- 2/ When FRAP/RAS ABR exceeds 20 percent for all mixes the high and low virgin asphalt binder grades shall each be reduced by one grade (i.e. 25 percent ABR would require a virgin asphalt binder grade of PG64-22 to be reduced to a PG58-28). If warm mix asphalt (WMA) technology is utilized, and production temperatures do not exceed 275 °F (135 °C) the high and low virgin asphalt binder grades shall each be reduced by one grade when FRAP/RAS ABR exceeds 25 percent (i.e. 26 percent ABR would require a virgin asphalt binder grade of PG64-22 to be reduced to a PG58-28).

3/ For SMA the FRAP/RAS ABR shall not exceed 20 percent.

4/ For IL-4.75 mix the FRAP/RAS ABR shall not exceed 30 percent.

1031.07 HMA Mix Designs. At the Contractor's option, HMA mixtures may be constructed utilizing RAP/FRAP and/or RAS material meeting the above detailed requirements.

FRAP/RAS mix designs exceeding the Level 1 FRAP/RAS Maximum ABR percentages shall be tested prior to submittal for verification, according to Illinois Modified AASHTO T 324 (Hamburg Wheel) and shall meet the following requirements.

Asphalt Binder Grade	# Repetitions	Max. Rut Depth in. (mm)
PG76-XX	20,000	1/2 (12.5)
PG70-XX	15,000	1/2 (12.5)
PG64-XX	7,500	1/2 (12.5)
PG58-XX	5,000	1/2 (12.5)

- (a) RAP/FRAP and/or RAS. RAP/FRAP and/or RAS designs shall be submitted for volumetric verification. If additional RAP/FRAP stockpiles are tested and found that no more than 20 percent of the results, as defined under "Testing" herein, are outside of the control tolerances set for the original RAP/FRAP stockpile and HMA mix design, and meets all of the requirements herein, the additional RAP/FRAP stockpiles may be used in the original mix design at the percent previously verified.
- (b) RAS. Type 1 and Type 2 RAS are not interchangeable in a mix design. A RAS stone bulk specific gravity (Gsb) of 2.500 shall be used for mix design purposes.

1031.08 HMA Production. Mixture production where the FRAP/RAS ABR percentage exceeds the Level 1 limits, shall be sampled within the first 500 tons (450 metric tons) on the first day of production with a split reserved for the Department. The mix sample shall be tested according to the Illinois Modified AASHTO T 324 and shall meet the requirements specified herein. Mix production shall not exceed 1500 tons (1350 metric tons) or one day's production, whichever comes first, until the testing is completed and the mixture is found to be in conformance. The requirement to cease mix production may be waived if the plant produced mixture conformance is demonstrated prior to start of mix production for a State contract.

- (a) RAP/FRAP. The coarse aggregate in all RAP/FRAP used shall be equal to or less than the nominal maximum size requirement for the HMA mixture being produced.

To remove or reduce agglomerated material, a scalping screen, gator, crushing unit, or comparable sizing device approved by the Engineer shall be used in the RAP feed system to remove or reduce oversized material. If material passing the sizing device adversely affects the mix production or quality of the mix, the sizing device shall be set at a size specified by the Engineer.

If the RAP/FRAP control tolerances or QC/QA test results require corrective action, the Contractor shall cease production of the mixture containing RAP/FRAP and either switch to the virgin aggregate design or submit a new RAP/FRAP design.

- (b) RAS. RAS shall be incorporated into the HMA mixture either by a separate weight depletion system or by using the RAP weigh belt. Either feed system shall be interlocked with the aggregate feed or weigh system to maintain correct proportions for all rates of production and batch sizes. The portion of RAS shall be controlled accurately to within ± 0.5 percent of the amount of RAS utilized. When using the weight depletion system, flow indicators or sensing devices shall be provided and interlocked with the plant controls such that the mixture production is halted when RAS flow is interrupted.

When producing HMA containing RAS, a positive dust control system shall be utilized.

- (c) RAP/FRAP and/or RAS. HMA plants utilizing RAP/FRAP and/or RAS shall be capable of automatically recording and printing the following information.

(1) Dryer Drum Plants.

- a. Date, month, year, and time to the nearest minute for each print.
- b. HMA mix number assigned by the Department.
- c. Accumulated weight of dry aggregate (combined or individual) in tons (metric tons) to the nearest 0.1 ton (0.1 metric ton).
- d. Accumulated dry weight of RAP/FRAP/RAS in tons (metric tons) to the nearest 0.1 ton (0.1 metric ton).
- e. Accumulated mineral filler in revolutions, tons (metric tons), etc. to the nearest 0.1 unit.
- f. Accumulated asphalt binder in gallons (liters), tons (metric tons), etc. to the nearest 0.1 unit.
- g. Residual asphalt binder in the RAP/FRAP material as a percent of the total mix to the nearest 0.1 percent.
- h. Aggregate and RAP/FRAP moisture compensators in percent as set on the control panel. (Required when accumulated or individual aggregate and RAP/FRAP are printed in wet condition.)

(2) Batch Plants.

- a. Date, month, year, and time to the nearest minute for each print.

- b. HMA mix number assigned by the Department.
- c. Individual virgin aggregate hot bin batch weights to the nearest pound (kilogram).
- d. Mineral filler weight to the nearest pound (kilogram).
- f. RAP/FRAP/RAS weight to the nearest pound (kilogram).
- g. Virgin asphalt binder weight to the nearest pound (kilogram).
- h. Residual asphalt binder in the RAP/FRAP/RAS material as a percent of the total mix to the nearest 0.1 percent.

The printouts shall be maintained in a file at the plant for a minimum of one year or as directed by the Engineer and shall be made available upon request. The printing system will be inspected by the Engineer prior to production and verified at the beginning of each construction season thereafter.

1031.09 RAP in Aggregate Surface Course and Aggregate Shoulders. The use of RAP in aggregate surface course (temporary access entrances only) and aggregate wedge shoulders Type B shall be as follows.

- (a) Stockpiles and Testing. RAP stockpiles may be any of those listed in Article 1031.02, except "Non-Quality" and "FRAP". The testing requirements of Article 1031.03 shall not apply. RAP used to construct aggregate surface course and aggregate shoulders shall be according to the current Bureau of Materials and Physical Research's Policy Memorandum, "Reclaimed Asphalt Pavement (RAP) for Aggregate Applications".
- (b) Gradation. One hundred percent of the RAP material shall pass the 1 1/2 in. (37.5 mm) sieve. The RAP material shall be reasonably well graded from coarse to fine. RAP material that is gap-graded or single sized will not be accepted."

REMOVAL AND DISPOSAL OF REGULATED SUBSTANCES (BDE)

Effective: January 1, 2012

Revised: November 2, 2012

Revise Article 669.01 of the Standard Specifications to read:

“669.01 Description. This work shall consist of the transportation and proper disposal of contaminated soil and water. This work shall also consist of the removal, transportation, and proper disposal of underground storage tanks (UST), their content and associated underground piping to the point where the piping is above the ground, including determining the content types and estimated quantities.”

Revise Article 669.08 of the Standard Specifications to read:

“669.08 Contaminated Soil and/or Groundwater Monitoring. The Contractor shall hire a qualified environmental firm to monitor the area containing the regulated substances. The affected area shall be monitored with a photoionization detector (PID) utilizing a lamp of 10.6eV or greater or a flame ionization detector (FID). Any field screen reading on the PID or FID in excess of background levels indicates the potential presence of contaminated material requiring handling as a non-special waste, special waste, or hazardous waste. No excavated soils can be taken to a clean construction and demolition debris (CCDD) facility or an uncontaminated soil fill operation with detectable PID or FID meter readings that are above background. The PID or FID meter shall be calibrated on-site and background level readings taken and recorded daily. All testing shall be done by a qualified engineer/technician. Such testing and monitoring shall be included in the work. The Contractor shall identify the exact limits of removal of non-special waste, special waste, or hazardous waste. All limits shall be approved by the Engineer prior to excavation. The Contractor shall take all necessary precautions.

Based upon the land use history of the subject property and/or PID or FID readings indicating contamination, a soil or groundwater sample shall be taken from the same location and submitted to an approved laboratory. Soil or groundwater samples shall be analyzed for the contaminants of concern, including pH, based on the property's land use history or the parameters listed in the maximum allowable concentration (MAC) for chemical constituents in uncontaminated soil established pursuant to Subpart F of 35 Illinois Administrative Code 1100.605. The analytical results shall serve to document the level of soil contamination. Soil and groundwater samples may be required at the discretion of the Engineer to verify the level of soil and groundwater contamination.

Samples shall be grab samples (not combined with other locations). The samples shall be taken with decontaminated or disposable instruments. The samples shall be placed in sealed containers and transported in an insulated container to the laboratory. The container shall maintain a temperature of 39 °F (4 °C). All samples shall be clearly labeled. The labels shall indicate the sample number, date sampled, location and elevation, and any other observations.

The laboratory shall use analytical methods which are able to meet the lowest appropriate practical quantitation limits (PQL) or estimated quantitation limit (EQL) specified in "Test Methods for Evaluating Solid Wastes, Physical/Chemical Methods", EPA Publication No. SW-846 and "Methods for the Determination of Organic Compounds in Drinking Water", EPA, EMSL, EPA-600/4-88/039. For parameters where the specified cleanup objective is below the acceptable detection limit (ADL), the ADL shall serve as the cleanup objective. For other parameters the ADL shall be equal to or below the specified cleanup objective."

Replace the first two paragraphs of Article 669.09 of the Standard Specifications with the following:

"669.09 Contaminated Soil and/or Groundwater Management and Disposal. The management and disposal of contaminated soil and/or groundwater shall be according to the following:

- (a) Soil Analytical Results Exceed Most Stringent MAC. When the soil analytical results indicate that detected levels exceed the most stringent maximum allowable concentration (MAC) for chemical constituents in uncontaminated soil established pursuant to Subpart F of 35 Illinois Administrative Code 1100.605, the soil shall be managed as follows:
 - (1) When analytical results indicate inorganic chemical constituents exceed the most stringent MAC but they are still considered within area background levels by the Engineer, the excavated soil can be utilized within the construction limits as fill, when suitable. Such soil excavated for storm sewers can be placed back into the excavated trench as backfill, when suitable, unless trench backfill is specified. If the soils cannot be utilized within the construction limits, they shall be managed and disposed of off-site as a non-special waste, special waste, or hazardous waste as applicable.
 - (2) When analytical results indicate chemical constituents exceed the most stringent MAC but do not exceed the MAC for a Metropolitan Statistical Area (MSA) County, the excavated soil can be utilized within the construction limits as fill, when suitable, or managed and disposed of off-site as "uncontaminated soil" at a CCDD facility or an uncontaminated soil fill operation within an MSA County provided the pH of the soil is within the range of 6.25 - 9.0, inclusive.
 - (3) When analytical results indicate chemical constituents exceed the most stringent MAC but do not exceed the MAC for an MSA County excluding Chicago, or the MAC within the Chicago corporate limits, the excavated soil can be utilized within the construction limits as fill, when suitable, or managed and disposed of off-site as "uncontaminated soil" at a CCDD facility or an uncontaminated soil fill operation within an MSA County excluding Chicago or within the Chicago corporate limits provided the pH of the soil is within the range of 6.25 - 9.0, inclusive.

- (4) When analytical results indicate chemical constituents exceed the most stringent MAC but do not exceed the MAC for an MSA County excluding Chicago, the excavated soil can be utilized within the construction limits as fill, when suitable, or managed and disposed of off-site as “uncontaminated soil” at a CCDD facility or an uncontaminated soil fill operation within an MSA County excluding Chicago provided the pH of the soil is within the range of 6.25 - 9.0, inclusive.
- (5) When the Engineer determines soil cannot be managed according to Articles 669.09(a)(1) through (a)(4) above, the soil shall be managed and disposed of off-site as a non-special waste, special waste, or hazardous waste as applicable.
- (b) Soil Analytical Results Do Not Exceed Most Stringent MAC. When the soil analytical results indicate that detected levels do not exceed the most stringent MAC but the pH of the soil is less than 6.25 or greater than 9.0, the excavated soil can be utilized within the construction limits or managed and disposed of off-site as “uncontaminated soil” according to Article 202.03. However the excavated soil cannot be taken to a CCDD facility or an uncontaminated soil fill operation.
- (c) Groundwater. When groundwater analytical results indicate the detected levels are above Appendix B, Table E of 35 Illinois Administrative Code 742, the most stringent Tier 1 Groundwater Remediation Objectives for Groundwater Component of the Groundwater Ingestion Route for Class 1 groundwater, the groundwater shall be managed off-site as a special waste.

All groundwater encountered within lateral trenches may be managed within the trench and allowed to infiltrate back into the ground. If the groundwater cannot be managed within the trench it must be removed as a special or hazardous waste. The Contractor is prohibited from managing groundwater within the trench by discharging it through any existing or new storm sewer. The Contractor shall install backfill plugs within the area of groundwater contamination.

One backfill plug shall be placed down gradient to the area of groundwater contamination. Backfill plugs shall be installed at intervals not to exceed 50 ft (15 m). Backfill plugs are to be 4 ft (1.2 m) long, measured parallel to the trench, full trench width and depth. Backfill plugs shall not have any fine aggregate bedding or backfill, but shall be entirely cohesive soil or any class of concrete. The Contractor shall provide test data that the material has a permeability of less than 10^{-7} cm/sec according to ASTM D 5084, Method A or per another test method approved by the Engineer.”

Revise Article 669.14 of the Standard Specifications to read:

“669.14 Final Environmental Construction Report. At the end of the project, the Contractor will prepare and submit three copies of the Environmental Construction Report on the activities conducted during the life of the project, one copy shall be submitted to the Resident Engineer, one copy shall be submitted to the District's Environmental Studies Unit, and one copy shall be submitted with an electronic copy in Adode.pdf format to the Geologic

and Waste Assessment Unit, Bureau of Design and Environment, IDOT, 2300 South Dirksen Parkway, Springfield, Illinois 62764. The technical report shall include all pertinent information regarding the project including, but not limited to:

- (a) Measures taken to identify, monitor, handle, and dispose of soil or groundwater containing regulated substances, to prevent further migration of regulated substances, and to protect workers,
- (b) Cost of identifying, monitoring, handling, and disposing of soil or groundwater containing regulated substances, the cost of preventing further migration of regulated substances, and the cost for worker protection from the regulated substances. All cost should be in the format of the contract pay items listed in the contract plans (identified by the preliminary environmental site investigation (PESA) site number),
- (c) Plan sheets showing the areas containing the regulated substances,
- (d) Field sampling and testing results used to identify the nature and extent of the regulated substances,
- (e) Waste manifests (identified by the preliminary environmental site investigation (PESA) site number) for special or hazardous waste disposal, and
- (f) Landfill tickets (identified by the preliminary environmental site investigation (PESA) site number) for non-special waste disposal.”

Revise the second paragraph of Article 669.16 of the Standard Specifications to read:

“The transportation and disposal of soil and other materials from an excavation determined to be contaminated will be paid for at the contract unit price per cubic yard (cubic meter) for NON-SPECIAL WASTE DISPOSAL, SPECIAL WASTE DISPOSAL, or HAZARDOUS WASTE DISPOSAL.”

REMOVAL AND DISPOSAL OF SURPLUS MATERIALS (BDE)

Effective: November 2, 2012

Revise the first four paragraphs of Article 202.03 of the Standard Specifications to read:

“202.03 Removal and Disposal of Surplus, Unstable, Unsuitable, and Organic Materials. Suitable excavated materials shall not be wasted without permission of the Engineer. The Contractor shall dispose of all surplus, unstable, unsuitable, and organic materials, in such a manner that public or private property will not be damaged or endangered.

Suitable earth, stones and boulders naturally occurring within the right-of-way may be placed in fills or embankments in lifts and compacted according to Section 205. Broken concrete without protruding metal bars, bricks, rock, stone, reclaimed asphalt pavement with no expansive aggregate, or uncontaminated dirt and sand generated from construction or demolition activities may be used in embankment or in fill. If used in fills or embankments, these materials shall be placed and compacted to the satisfaction of the Engineer; shall be buried under a minimum of 2 ft (600 mm) of earth cover (except when the materials include only uncontaminated dirt); and shall not create an unsightly appearance or detract from the natural topographic features of an area. Broken concrete without protruding metal bars, bricks, rock, or stone may be used as riprap as approved by the Engineer. If the materials are used for fill in locations within the right-of-way but outside project construction limits, the Contractor must specify to the Engineer, in writing, how the landscape restoration of the fill areas will be accomplished. Placement of fill in such areas shall not commence until the Contractor's landscape restoration plan is approved by the Engineer.

Aside from the materials listed above, all other construction and demolition debris or waste shall be disposed of in a licensed landfill, recycled, reused, or otherwise disposed of as allowed by State or Federal laws and regulations. When the Contractor chooses to dispose of uncontaminated soil at a clean construction and demolition debris (CCDD) facility or at an uncontaminated soil fill operation, it shall be the Contractor's responsibility to have the pH of the material tested to ensure the value is between 6.25 and 9.0, inclusive. A copy of the pH test results shall be provided to the Engineer.

A permit shall be obtained from IEPA and made available to the Engineer prior to open burning of organic materials (i.e., plant refuse resulting from pruning or removal of trees or shrubs) or other construction or demolition debris. Organic materials originating within the right-of-way limits may be chipped or shredded and placed as mulch around landscape plantings within the right-of-way when approved by the Engineer. Chipped or shredded material to be placed as mulch shall not exceed a depth of 6 in. (150 mm).”

WORKING DAYS (BDE)

Effective: January 1, 2002

The Contractor shall complete the work within 20 working days.

80071