



Local Public Agency
Formal Contract Proposal

PROPOSAL SUBMITTED BY		
Contractor's Name		
Street	P.O. Box	
City	State	Zip Code

STATE OF ILLINOIS

COUNTY OF DeKalb

(Name of City, Village, Town or Road District)

FOR THE IMPROVEMENT OF

STREET NAME OR ROUTE NO. Chicago Road

SECTION NO. 13-00236-00-RS

TYPES OF FUNDS MFT and Local

SPECIFICATIONS (required)

PLANS (required)

For Municipal Projects
Submitted/Approved/Passed

Mayor President of Board of Trustees Municipal Official

Date

Department of Transportation

Released for bid based on limited review

Regional Engineer

Date

For County and Road District Projects
Submitted/Approved

Highway Commissioner

Date

Submitted/Approved

County Engineer/Superintendent of Highways

Date

Note: All proposal documents, including Proposal Guaranty Checks or Proposal Bid Bonds, should be stapled together to prevent loss when bids are processed.

RETURN WITH BID

NOTICE TO BIDDERS

County DeKalb
Local Public Agency DeKalb County
Section Number 13-00236-00-RS
Route Chicago Road

Sealed proposals for the improvement described below will be received at the office of the DeKalb County Engineer, 1826 Barber Greene Road, DeKalb, IL 60115 until 10:00 AM on April 2, 2015

Sealed proposals will be opened and read publicly at the office of the DeKalb County Engineer 1826 Barber Greene Road, DeKalb, IL 60115 at 10:00 AM on April 2, 2015

DESCRIPTION OF WORK

Name Chicago Road Length: 24095.00 feet (4.56 miles)
Location 5 miles north of Somonauk, IL
Proposed Improvement HMA overlay with other incidental work

1. Plans and proposal forms will be available in the office of the DeKalb County Engineer 1826 Barber Greene Road, DeKalb, IL 60115

2. [X] Prequalification
If checked, the 2 low bidders must file within 24 hours after the letting an "Affidavit of Availability" (Form BC 57), in duplicate, showing all uncompleted contracts awarded to them and all low bids pending award for Federal, State, County, Municipal and private work.

3. The Awarding Authority reserves the right to waive technicalities and to reject any or all proposals as provided in BLRS Special Provision for Bidding Requirements and Conditions for Contract Proposals.

4. The following BLR Forms shall be returned by the bidder to the Awarding Authority:
a. BLR 12200: Local Public Agency Formal Contract Proposal
b. BLR 12200a Schedule of Prices
c. BLR 12230: Proposal Bid Bond (if applicable)
d. BLR 12325: Apprenticeship or Training Program Certification (do not use for federally funded projects)
e. BLR 12326: Affidavit of Illinois Business Office

5. The quantities appearing in the bid schedule are approximate and are prepared for the comparison of bids. Payment to the Contractor will be made only for the actual quantities of work performed and accepted or materials furnished according to the contract.

6. Submission of a bid shall be conclusive assurance and warranty the bidder has examined the plans and understands all requirements for the performance of work. The bidder will be responsible for all errors in the proposal resulting from failure or neglect to conduct an in depth examination.

7. The bidder shall take no advantage of any error or omission in the proposal and advertised contract.

8. If a special envelope is supplied by the Awarding Authority, each proposal should be submitted in that envelope furnished by the Awarding Agency and the blank spaces on the envelope shall be filled in correctly to clearly indicate its contents. When an envelope other than the special one furnished by the Awarding Authority is used, it shall be marked to clearly indicate its contents.

9. Permission will be given to a bidder to withdraw a proposal if the bidder makes the request in writing or in person before the time for opening proposals.

RETURN WITH BID

PROPOSAL

County DeKalb
Local Public Agency DeKalb County
Section Number 13-00236-00-RS
Route Chicago Road

- 1. Proposal of ... for the improvement of the above section by the construction of HMA overlay with other incidental work on Chicago Road approximately 5 miles north of Somonauk, IL
a total distance of 24095.00 feet, of which a distance of 24095.00 feet, (4.560 miles) are to be improved.
2. The plans for the proposed work are those prepared by the DeKalb County Highway Department and approved by the Department of Transportation on ...
3. The specifications referred to herein are those prepared by the Department of Transportation and designated as "Standard Specifications for Road and Bridge Construction" and the "Supplemental Specifications and Recurring Special Provisions" thereto, adopted and in effect on the date of invitation for bids.
4. The undersigned agrees to accept, as part of the contract, the applicable Special Provisions indicated on the "Check Sheet for Recurring Special Provisions" contained in this proposal.
5. The undersigned agrees to complete the work within ... working days or by 10/16/2015 unless additional time is granted in accordance with the specifications.
6. A proposal guaranty in the proper amount, as specified in BLRS Special Provision for Bidding Requirements and Conditions for Contract Proposals, will be required. Bid Bonds will be allowed as a proposal guaranty. Accompanying this proposal is either a bid bond if allowed, on Department form BLR 12230 or a proposal guaranty check, complying with the specifications, made payable to:
the DeKalb County Treasurer of ...
The amount of the check is ... (...).
7. In the event that one proposal guaranty check is intended to cover two or more proposals, the amount must be equal to the sum of the proposal guaranties, which would be required for each individual proposal. If the proposal guaranty check is placed in another proposal, it will be found in the proposal for: Section Number ...
8. The successful bidder at the time of execution of the contract will be required to deposit a contract bond for the full amount of the award. When a contract bond is not required, the proposal guaranty check will be held in lieu thereof. If this proposal is accepted and the undersigned fails to execute a contract and contract bond as required, it is hereby agreed that the Bid Bond or check shall be forfeited to the Awarding Authority.
9. Each pay item should have a unit price and a total price. If no total price is shown or if there is a discrepancy between the product of the unit price multiplied by the quantity, the unit price shall govern. If a unit price is omitted, the total price will be divided by the quantity in order to establish a unit price.
10. A bid will be declared unacceptable if neither a unit price nor a total price is shown.
11. The undersigned submits herewith the schedule of prices on BLR 12200a covering the work to be performed under this contract.
12. The undersigned further agrees that if awarded the contract for the sections contained in the combinations on BLR 12200a, the work shall be in accordance with the requirements of each individual proposal for the multiple bid specified in the Schedule for Multiple Bids below.

RETURN WITH BID

CONTRACTOR CERTIFICATIONS

County	<u>DeKalb</u>
Local Public Agency	<u>DeKalb County</u>
Section Number	<u>13-00236-00-RS</u>
Route	<u>Chicago Road</u>

The certifications hereinafter made by the bidder are each a material representation of fact upon which reliance is placed should the Department enter into the contract with the bidder.

1. **Debt Delinquency.** The bidder or contractor or subcontractor, respectively, certifies that it is not delinquent in the payment of any tax administered by the Department of Revenue unless the individual or other entity is contesting, in accordance with the procedures established by the appropriate revenue Act, its liability for the tax or the amount of tax. Making a false statement voids the contract and allows the Department to recover all amounts paid to the individual or entity under the contract in a civil action.

2. **Bid-Rigging or Bid Rotating.** The bidder or contractor or subcontractor, respectively, certifies that it is not barred from contracting with the Department by reason of a violation of either 720 ILCS 5/33E-3 or 720 ILCS 5/33E-4.

A violation of Section 33E-3 would be represented by a conviction of the crime of bid-rigging which, in addition to Class 3 felony sentencing, provides that any person convicted of this offense or any similar offense of any state or the United States which contains the same elements as this offense shall be barred for 5 years from the date of conviction from contracting with any unit of State or local government. No corporation shall be barred from contracting with any unit of State or local government as a result of a conviction under this Section of any employee or agent of such corporation if the employee so convicted is no longer employed by the corporation and: (1) it has been finally adjudicated not guilty or (2) if it demonstrates to the governmental entity with which it seeks to contract and that entity finds that the commission of the offense was neither authorized, requested, commanded, nor performed by a director, officer or a high managerial agent in behalf of the corporation.

A violation of Section 33E-4 would be represented by a conviction of the crime of bid-rotating which, in addition to Class 2 felony sentencing, provides that any person convicted of this offense or any similar offense of any state or the United States which contains the same elements as this offense shall be permanently barred from contracting with any unit of State or local government. No corporation shall be barred from contracting with any unit of State or local government as a result of a conviction under this Section of any employee or agent of such corporation if the employee so convicted is no longer employed by the corporation and: (1) it has been finally adjudicated not guilty or (2) if it demonstrates to the governmental entity with which it seeks to contract and that entity finds that the commission of the offense was neither authorized, requested, commanded, nor performed by a director, officer or a high managerial agent in behalf of the corporation.

3. **Bribery.** The bidder or contractor or subcontractor, respectively, certifies that it has not been convicted of bribery or attempting to bribe an officer or employee of the State of Illinois or any unit of local government, nor has the firm made an admission of guilt of such conduct which is a matter of record, nor has an official, agent, or employee of the firm committed bribery or attempted bribery on behalf of the firm and pursuant to the direction or authorization of a responsible official of the firm.

4. **Interim Suspension or Suspension.** The bidder or contractor or subcontractor, respectively, certifies that it is not currently under a suspension as defined in Subpart I of Title 44 Subtitle A Chapter III Part 6 of the Illinois Administrative Code. Furthermore, if suspended prior to completion of this work, the contract or contracts executed for the completion of this work may be cancelled.

RETURN WITH BID

SIGNATURES

County DeKalb
Local Public Agency DeKalb County
Section Number 13-00236-00-RS
Route Chicago Road

(If an individual)

Signature of Bidder

Business Address

(If a partnership)

Firm Name

Signed By

Business Address

Inset Names and Addressed of All Partners



(If a corporation)

Corporate Name

Signed By

President

Business Address

Inset Names of Officers



President

Secretary

Treasurer

Attest: Secretary



Route Chicago Road
County DeKalb
Local Agency DeKalb County
Section 13-00236-00-RS

RETURN WITH BID

PAPER BID BOND

WE _____ as PRINCIPAL,
and _____ as SURETY,
are held jointly, severally and firmly bound unto the above Local Agency (hereafter referred to as "LA") in the penal sum of 5% of the total bid price, or for the amount specified in the proposal documents in effect on the date of invitation for bids whichever is the lesser sum. We bind ourselves, our heirs, executors, administrators, successors, and assigns, jointly pay to the LA this sum under the conditions of this instrument.

WHEREAS THE CONDITION OF THE FOREGOING OBLIGATION IS SUCH that, the said PRINCIPAL is submitting a written proposal to the LA acting through its awarding authority for the construction of the work designated as the above section.

THEREFORE if the proposal is accepted and a contract awarded to the PRINCIPAL by the LA for the above designated section and the PRINCIPAL shall within fifteen (15) days after award enter into a formal contract, furnish surety guaranteeing the faithful performance of the work, and furnish evidence of the required insurance coverage, all as provided in the "Standard Specifications for Road and Bridge Construction" and applicable Supplemental Specifications, then this obligation shall become void; otherwise it shall remain in full force and effect.

IN THE EVENT the LA determines the PRINCIPAL has failed to enter into a formal contract in compliance with any requirements set forth in the preceding paragraph, then the LA acting through its awarding authority shall immediately be entitled to recover the full penal sum set out above, together with all court costs, all attorney fees, and any other expense of recovery.

IN TESTIMONY WHEREOF, the said PRINCIPAL and the said SURETY have caused this instrument to be signed by their respective officers this _____ day of _____

Principal

(Company Name) _____
By: _____ By: _____
(Signature and Title) (Signature and Title)

(If PRINCIPLE is a joint venture of two or more contractors, the company names, and authorized signatures of each contractor must be affixed.)

Surety

(Name of Surety) By: _____
(Signature of Attorney-in-Fact)

STATE OF ILLINOIS,
COUNTY OF _____

I, _____, a Notary Public in and for said county,
do hereby certify that _____

(Insert names of individuals signing on behalf of PRINCIPAL & SURETY)

who are each personally known to me to be the same persons whose names are subscribed to the foregoing instrument on behalf of PRINCIPAL and SURETY, appeared before me this day in person and acknowledged respectively, that they signed and delivered said instruments as their free and voluntary act for the uses and purposes therein set forth.

Given under my hand and notarial seal this _____ day of _____

My commission expires _____
(Notary Public)

ELECTRONIC BID BOND

[X] Electronic bid bond is allowed (box must be checked by LA if electronic bid bond is allowed)
The Principal may submit an electronic bid bond, in lieu of completing the above section of the Proposal Bid Bond Form. By providing an electronic bid bond ID code and signing below, the Principal is ensuring the identified electronic bid bond has been executed and the Principal and Surety are firmly bound unto the LA under the conditions of the bid bond as shown above. (If PRINCIPAL is a joint venture of two or more contractors, an electronic bid bond ID code, company/Bidder name title and date must be affixed for each contractor in the venture.)

Electronic Bid Bond ID Code

(Company/Bidder Name)

(Signature and Title) _____
Date



Apprenticeship or Training Program Certification

Return with Bid

Route Chicago Road
County DeKalb
Local Agency DeKalb County
Section 13-00236-00-RS

All contractors are required to complete the following certification:

- For this contract proposal or for all groups in this deliver and install proposal.
For the following deliver and install groups in this material proposal:

Blank lines for listing deliver and install groups.

Illinois Department of Transportation policy, adopted in accordance with the provisions of the Illinois Highway Code, requires this contract to be awarded to the lowest responsive and responsible bidder. The award decision is subject to approval by the Department. In addition to all other responsibility factors, this contract or deliver and install proposal requires all bidders and all bidders' subcontractors to disclose participation in apprenticeship or training programs that are (1) approved by and registered with the United States Department of Labor's Bureau of Apprenticeship and Training, and (2) applicable to the work of the above indicated proposals or groups. Therefore, all bidders are required to complete the following certification:

- I. Except as provided in paragraph IV below, the undersigned bidder certifies that it is a participant, either as an individual or as part of a group program, in an approved apprenticeship or training program applicable to each type of work or craft that the bidder will perform with its own employees.
II. The undersigned bidder further certifies for work to be performed by subcontract that each of its subcontractors submitted for approval either (A) is, at the time of such bid, participating in an approved, applicable apprenticeship or training program; or (B) will, prior to commencement of performance of work pursuant to this contract, establish participation in an approved apprenticeship or training program applicable to the work of the subcontract.
III. The undersigned bidder, by inclusion in the list in the space below, certifies the official name of each program sponsor holding the Certificate of Registration for all of the types of work or crafts in which the bidder is a participant and that will be performed with the bidder's employees. Types of work or craft that will be subcontracted shall be included and listed as subcontract work. The list shall also indicate any type of work or craft job category for which there is no applicable apprenticeship or training program available.

Blank lines for listing program sponsors and subcontracted work.

IV. Except for any work identified above, any bidder or subcontractor that shall perform all or part of the work of the contract or deliver and install proposal solely by individual owners, partners or members and not by employees to whom the payment of prevailing rates of wages would be required, check the following box, and identify the owner/operator workforce and positions of ownership.

The requirements of this certification and disclosure are a material part of the contract, and the contractor shall require this certification provision to be included in all approved subcontracts. The bidder is responsible for making a complete report and shall make certain that each type of work or craft job category that will be utilized on the project is accounted for and listed. The Department at any time before or after award may require the production of a copy of each applicable Certificate of Registration issued by the United States Department of Labor evidencing such participation by the contractor and any or all of its subcontractors. In order to fulfill the participation requirement, it shall not be necessary that any applicable program sponsor be currently taking or that it will take applications for apprenticeship, training or employment during the performance of the work of this contract or deliver and install proposal.

Bidder: _____

By: _____

(Signature)

Address: _____

Title: _____



Affidavit of Illinois Business Office

County DeKalb
Local Public Agency DeKalb County
Section Number 13-00236-00-RS
Route Chicago Road

State of _____)
) ss.
County of _____)

I, _____ of _____, _____,
(Name of Affiant) (City of Affiant) (State of Affiant)

being first duly sworn upon oath, states as follows:

- 1. That I am the _____ of _____ bidder.
officer or position
2. That I have personal knowledge of the facts herein stated.
3. That, if selected under this proposal, _____, will maintain a
(bidder)
business office in the State of Illinois which will be located in _____ County, Illinois.
4. That this business office will serve as the primary place of employment for any persons employed in the
construction contemplated by this proposal.
5. That this Affidavit is given as a requirement of state law as provided in Section 30-22(8) of the Illinois
Procurement Code.

(Signature)

(Print Name of Affiant)

This instrument was acknowledged before me on _____ day of _____, _____.

(SEAL)

(Signature of Notary Public)



Illinois Department of Transportation

Bureau of Construction
2300 South Dirksen Parkway/Room 322
Springfield, Illinois 62764

Affidavit of Availability For the Letting of 4/2/2015

Instructions: Complete this form by either typing or using black ink. "Authorization to Bid" will not be issued unless both sides of this form are completed in detail. Use additional forms as needed to list all work.

Part I. Work Under Contract

List below all work you have under contract as either a prime contractor or a subcontractor. It is required to include all pending low bids not yet awarded or rejected. In a joint venture, list only that portion of the work which is the responsibility of your company. The uncompleted dollar value is to be based upon the most recent engineer's or owners estimate, and must include work subcontracted to others. If no work is contracted, show **NONE**.

	1	2	3	4	Awards Pending	
Contract Number						
Contract With						
Estimated Completion Date						
Total Contract Price						Accumulated Totals
Uncompleted Dollar Value if Firm is the Prime Contractor						
Uncompleted Dollar Value if Firm is the Subcontractor						
Total Value of All Work						

Part II. Awards Pending and Uncompleted Work to be done with your own forces.

List below the uncompleted dollar value of work for each contract and awards pending to be completed with your own forces. All work subcontracted to others will be listed on the reverse of this form. In a joint venture, list only that portion of the work to be done by your company. If no work is contracted, show **NONE**.

						Accumulated Totals
Earthwork						
Portland Cement Concrete Paving						
HMA Plant Mix						
HMA Paving						
Clean & Seal Cracks/Joints						
Aggregate Bases & Surfaces						
Highway, R.R. and Waterway Structures						
Drainage						
Electrical						
Cover and Seal Coats						
Concrete Construction						
Landscaping						
Fencing						
Guardrail						
Painting						
Signing						
Cold Milling, Planning & Rotomilling						
Demolition						
Pavement Markings (Paint)						
Other Construction (List)						
Totals						

Disclosure of this information is **REQUIRED** to accomplish the statutory purpose as outlined in the "Illinois Procurement Code." Failure to comply will result in non-issuance of an "Authorization To Bid." This form has been approved by the State Forms Management Center.

Part III. Work Subcontracted to Others.

For each contract described in Part I, list all the work you have subcontracted to others.

	1	2	3	4	Awards Pending
Subcontractor					
Type of Work					
Subcontract Price					
Amount Uncompleted					
Subcontractor					
Type of Work					
Subcontract Price					
Amount Uncompleted					
Subcontractor					
Type of Work					
Subcontract Price					
Amount Uncompleted					
Subcontractor					
Type of Work					
Subcontract Price					
Amount Uncompleted					
Subcontractor					
Type of Work					
Subcontract Price					
Amount Uncompleted					
Subcontractor					
Type of Work					
Subcontract Price					
Amount Uncompleted					
Total Uncompleted					

I, being duly sworn, do hereby declare that this affidavit is a true and correct statement relating to ALL uncompleted contracts of the undersigned for Federal, State, County, City and private work, including ALL subcontract work, ALL pending low bids not yet awarded or rejected and ALL estimated completion dates.

Subscribed and sworn to before me
 this _____ day of _____, _____ Type or Print Name _____
 Officer or Director Title

Signed _____

 Notary Public

My commission expires _____

(Notary Seal)

Company _____

Address _____

DeKalb County
Section 13-00236-00-RS

<u>Location</u>	<u>From</u>	<u>To</u>
Chicago Road	250 ft east of Maplewood Road	EOP on west side of Somonauk Road

<u>Hot Mix Material</u>	<u>Asphalt Thickness</u>	<u>Length</u>	<u>Width</u>	<u>Area</u>
LB (MM), IL-9.5 FG, N50	1 in	24095 ft	28 ft	74962 sq yd
HMA SC, Mix "C", N50	1.25 in	24095 ft	28 ft	74962 sq yd
HMA Shoulders, Special	3 in	48190 ft	3 ft	16063 sq yd

Additional Paving Areas

<u>Area Type</u>	<u>Number of areas</u>	<u>Estimated Area</u>	<u>Additional Total Area</u>
Driveway	34	55 sq yd	1870 sq yd
Sideroads	6	200 sq yd	1200 sq yd
Field Entrances	0	20 sq yd	0 sq yd

Schedule of Quantities

<u>Pay Item</u>	<u>Unit</u>	<u>Quantity</u>
Bituminous Materials (Prime Coat)	Pound	9868
Hot Mix Asphalt Surface Removal (Butt Joint)	Sq Yd	1255
Leveling Binder (Machine Method), IL-9.5FG, N50	Ton	4370
Hot Mix Asphalt Surface Course, Mix C, N50	Ton	5591
Aggregate Shoulder, Type B	Ton	1325
Hot Mix Asphalt Shoulders, Special	Ton	2699
Short Term Pavement Marking	Foot	3620
Thermoplastic Pavement Marking - Line 4"	Foot	96380

Quantities are estimate prepared for the establishment of pay item prices and are the responsibility of the contractor to confirm prior to bidding. Quantities may be increased, decreased, or omitted to satisfactorily complete the project.

LOCATION MAP DEKALB COUNTY

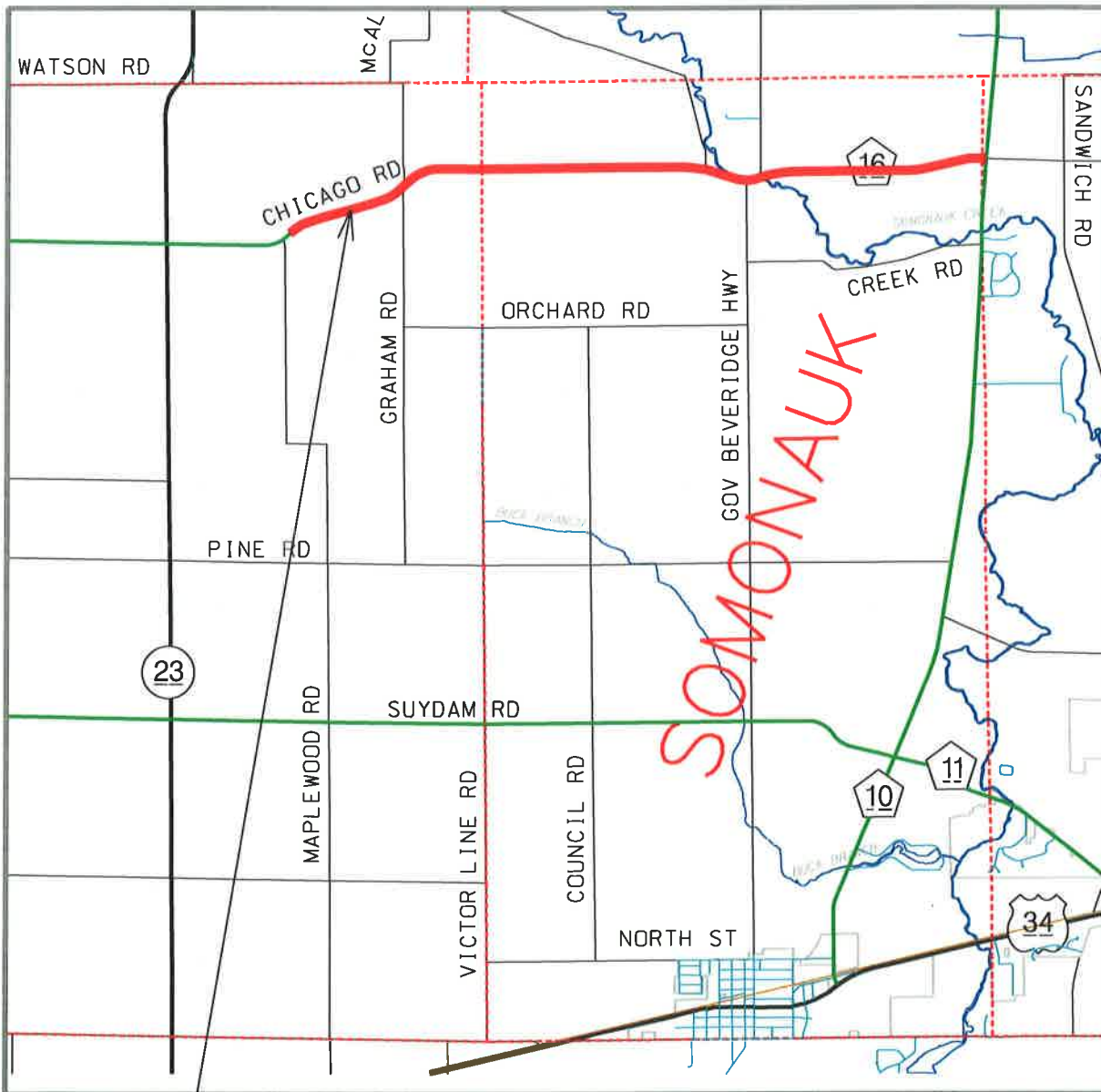
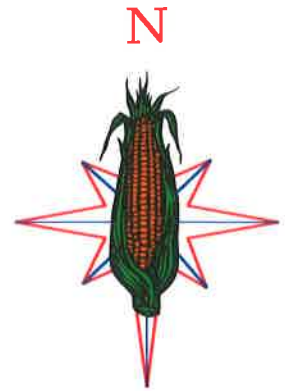

SECTION 13-00236-00-RS
DEKALB COUNTY / CHICAGO ROAD
LOCATION OF HOT-MIX ASPHALT RESURFACING

TYPICAL SECTION

DEKALB COUNTY
CHICAGO ROAD

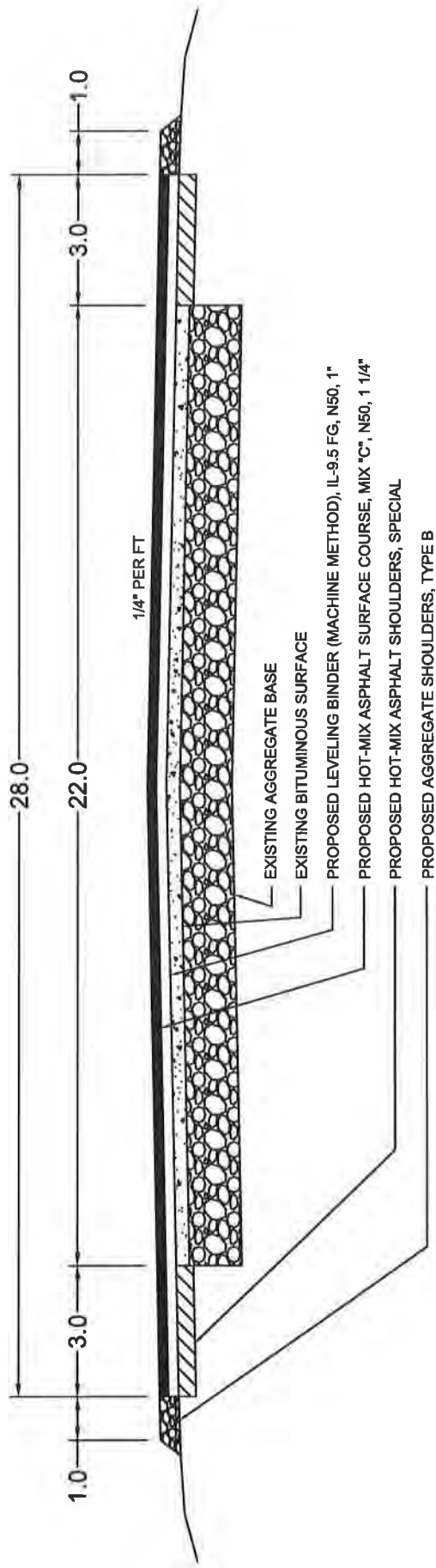

SECTION 13-00236-00-RS

JOINT TAPER DETAIL

DEKALB COUNTY
CHICAGO ROAD

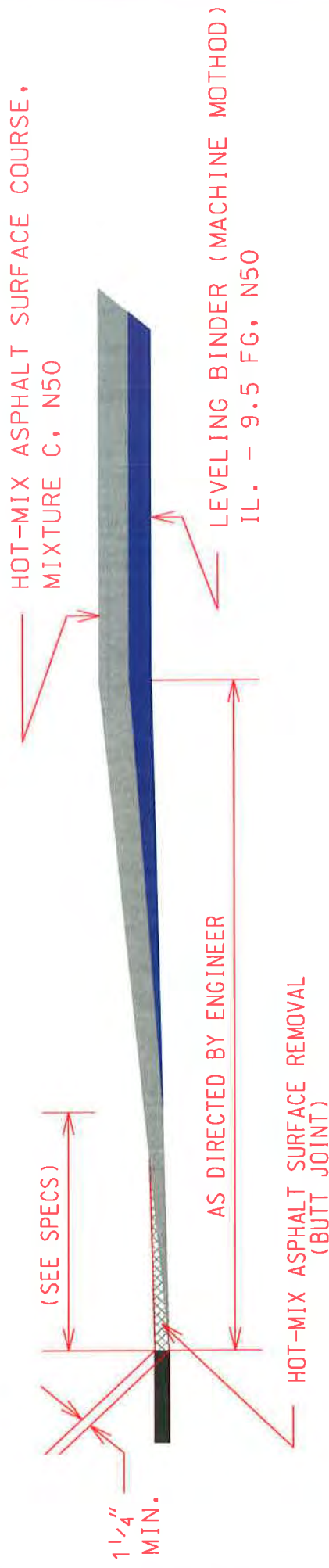

SECTION 13-00236-00-RS

ENTRANCE DETAIL

DEKALB COUNTY

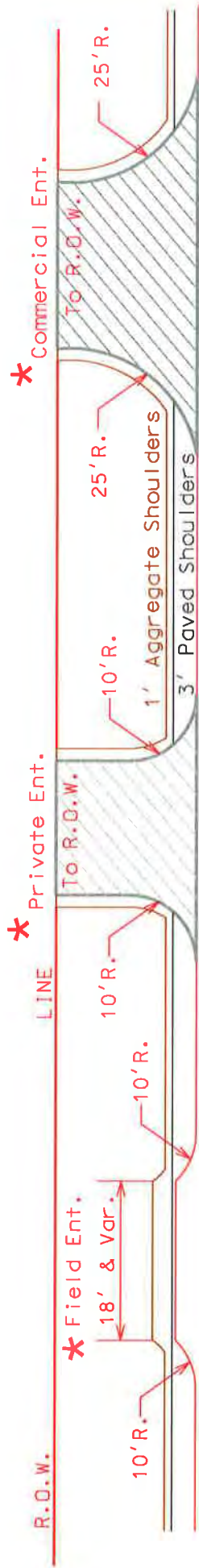

CHICAGO ROAD

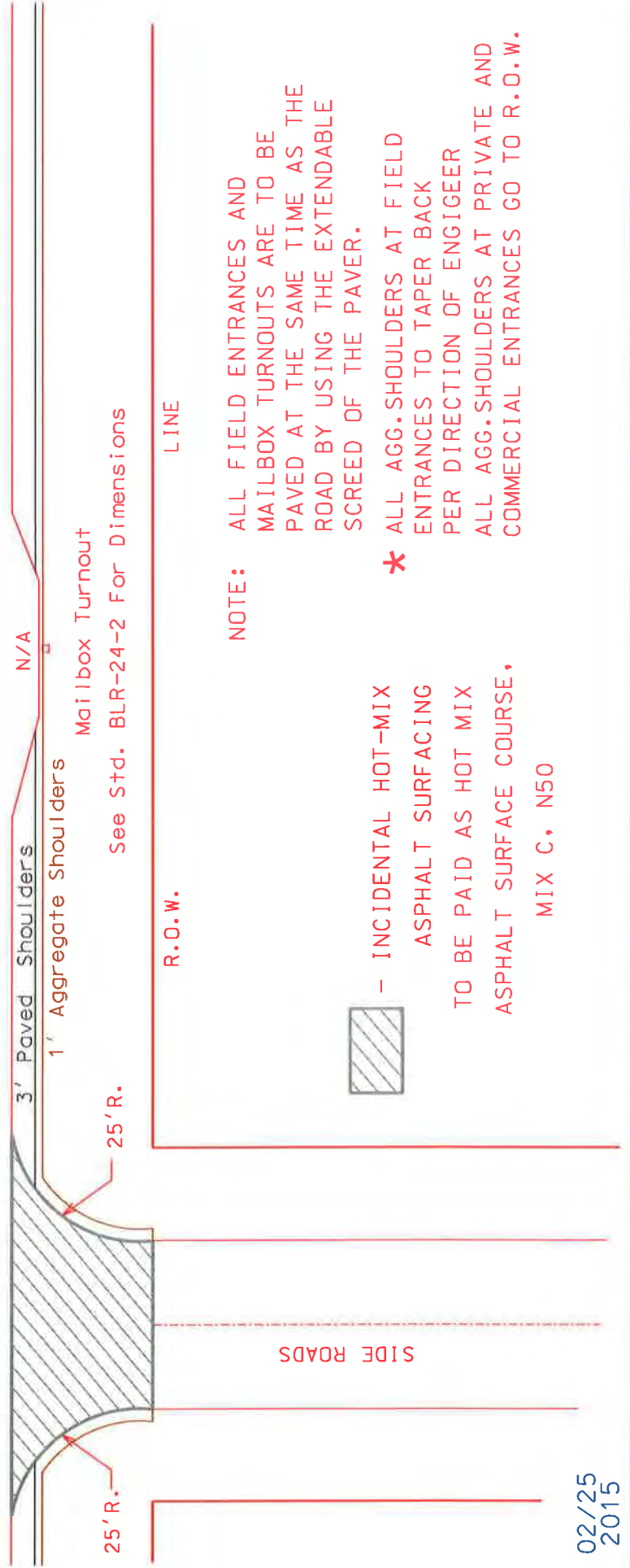

See Std. BLR-24-2 For Dimensions

NOTE: ALL FIELD ENTRANCES AND MAILBOX TURNOUTS ARE TO BE PAVED AT THE SAME TIME AS THE ROAD BY USING THE EXTENDABLE SCREED OF THE PAVER.

***** ALL AGG. SHOULDERS AT FIELD ENTRANCES TO TAPER BACK PER DIRECTION OF ENGINEER
ALL AGG. SHOULDERS AT PRIVATE AND COMMERCIAL ENTRANCES GO TO R.O.W.



- INCIDENTAL HOT-MIX ASPHALT SURFACING TO BE PAID AS HOT MIX ASPHALT SURFACE COURSE, MIX C, N50

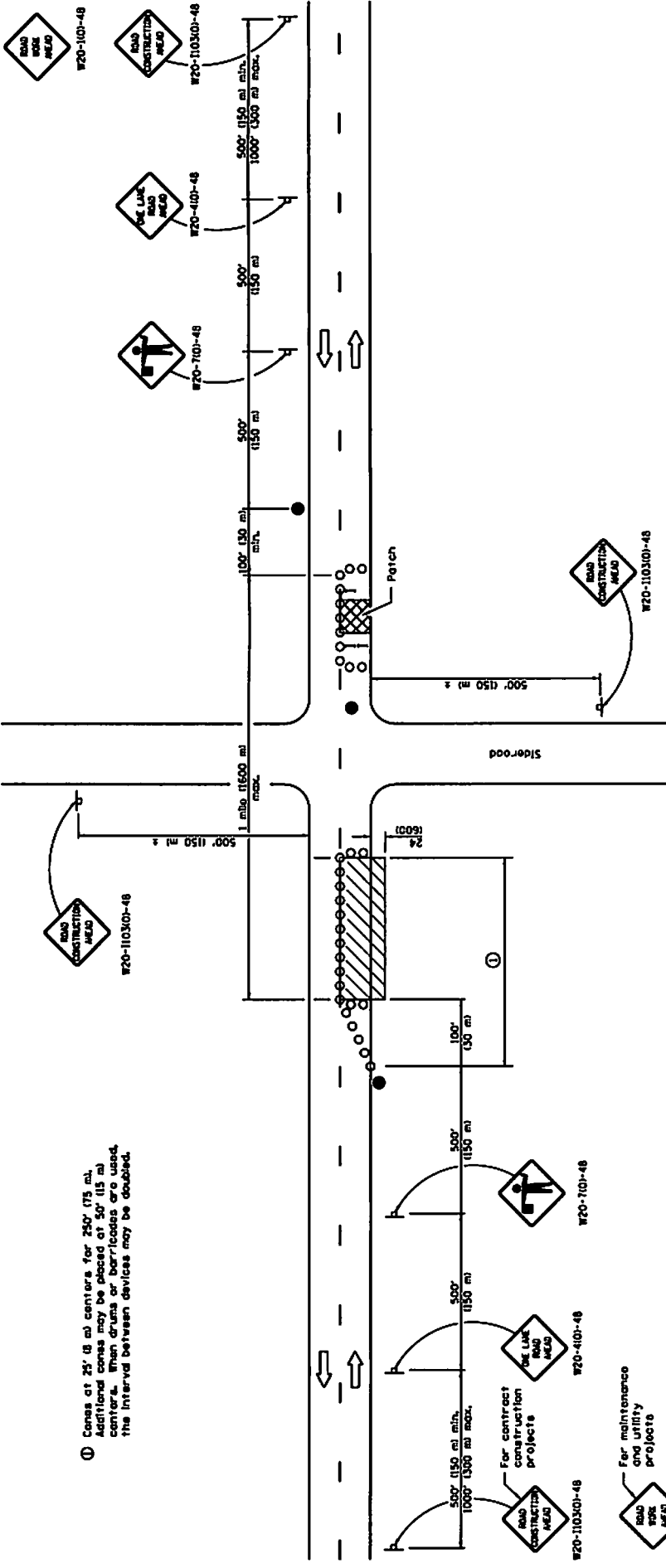

① Cones at 25' (8 m) centers for 250' (75 m). Additional cones may be placed at 50' (15 m) centers. When drums or barricades are used, the interval between devices may be doubled.

GENERAL NOTES
 This Standard is used where, at any time, any vehicles, equipment, workers or their activities will encroach in the area between the center line and a line 24 (600) outside the edge of pavement for daylight operation.
 When the distance between successive work areas exceeds 2000' (600 m), additional warning signs, flaggers, and taper and be placed as shown.
 All dimensions are in inches (millimeters) unless otherwise shown.

SYMBOLS

- Work area
- Sign
- Barricade or drum
- Cone, drum or barricade
- Flagger with traffic control sign

TYPICAL APPLICATIONS

- Isolated patching
- Utility operations
- Storm sewer
- Culverts
- Cable placement

DATE	REVISIONS
1-1-11	Revised flagger sign.
1-1-09	Switched units to English (metric).
	Corrected sign No.'s.

LANE CLOSURE, 2L, 2W, DAY ONLY, FOR SPEEDS ≥ 45 MPH
 STANDARD 701201-04

Illinois Department of Transportation

ISSUED 1-1-91

APPROVED: [Signature] R11
 CHECKED BY: [Signature] R11
 APPROVED: [Signature] R11
 APPROVED: [Signature] R11

OFFICE OF ROUTE AND DISTRICTS

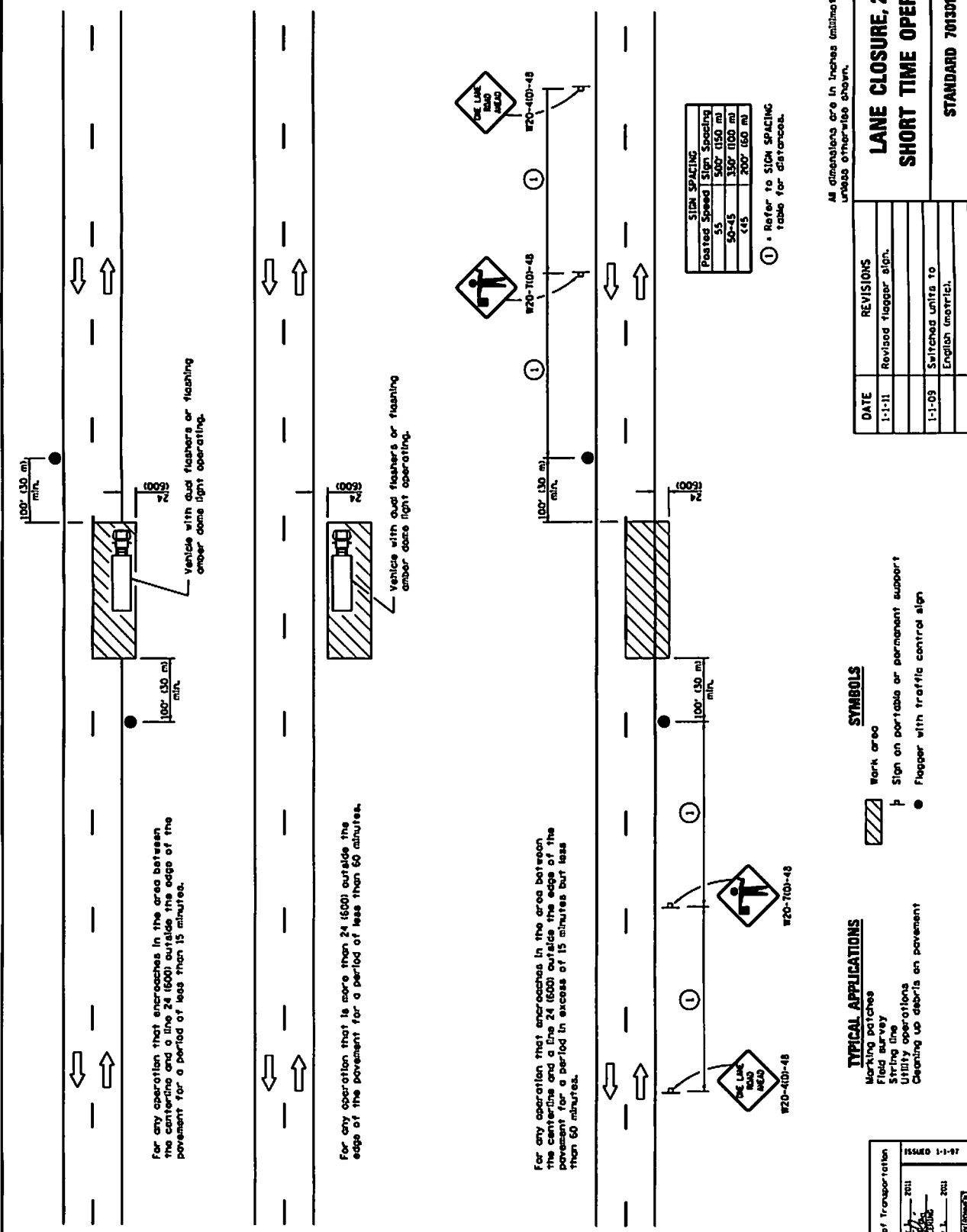

ISSUED 1-1-07

16-1-0955

APPROVED: [Signature] 2011

DESIGNED BY: [Signature] 2011

APPROVED: [Signature] 2011

OFFICE OF DESIGN AND CONSTRUCTION

LANE CLOSURE, 2L, 2W, SHORT TIME OPERATIONS

STANDARD 701301-04

All dimensions are in inches (millimeters) unless otherwise shown.

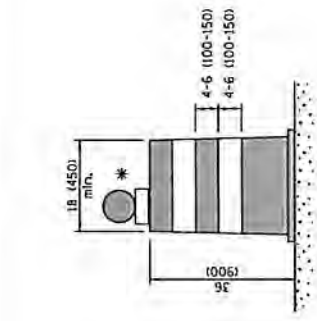

DRUM

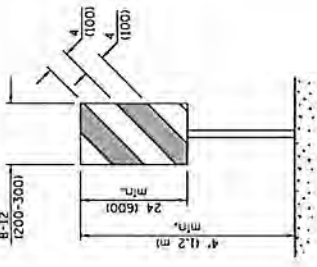

**VERTICAL PANEL
POST MOUNTED**

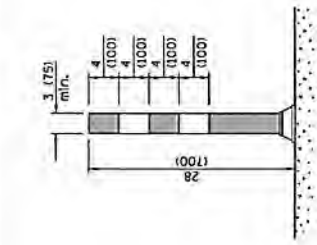

FLEXIBLE DELINEATOR

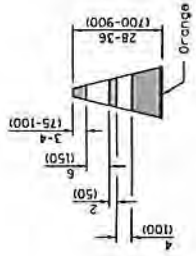

REFLECTORIZED CONE

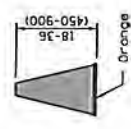

CONE

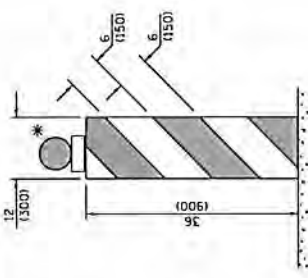

VERTICAL BARRICADE

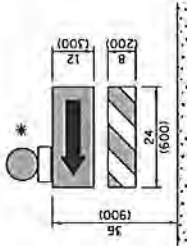

**DIRECTION INDICATOR
BARRICADE**

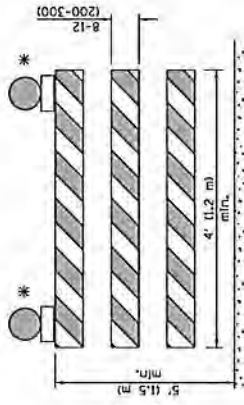

TYPE III BARRICADE

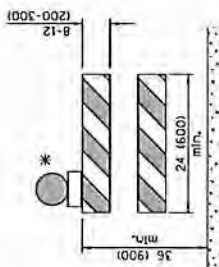

TYPE II BARRICADE

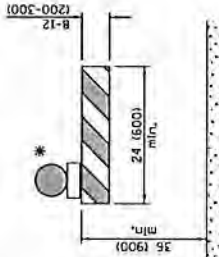

TYPE I BARRICADE

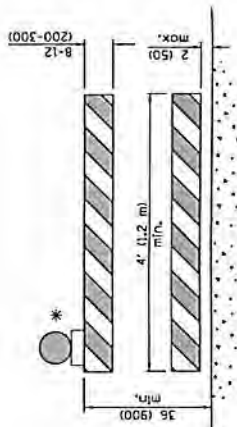

**DETECTABLE PEDESTRIAN
CHANNELIZING BARRICADE**

* Warning lights, (if required)

GENERAL NOTES
All heights shown shall be measured above the pavement surface.
All dimensions are in inches (millimeters) unless otherwise shown.

DATE	REVISIONS
1-1-15	Revised two sign numbers on sheet 2. Added note req. PHOTO ENFORCED placue.
1-1-14	Modified flagger sign height. Added highway construction speed zone signs.

**TRAFFIC CONTROL
DEVICES**

(Sheet 1 of 3)

STANDARD 701901-04

Illinois Department of Transportation
 APPROVED: [Signature] JANUARY 1, 2015
 ENGINEER OF OPERATIONS
 APPROVED: [Signature] JANUARY 1, 2015
 ENGINEER OF DESIGN AND ENVIRONMENT

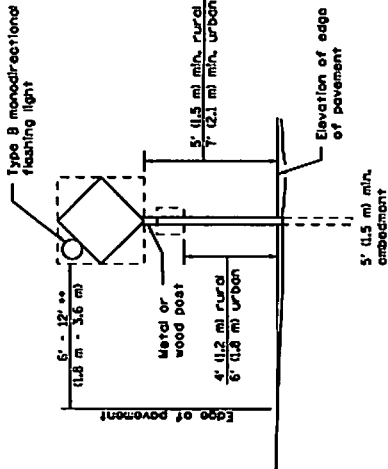

POST MOUNTED SIGNS

** When curb or paved shoulder are present this dimension shall be 24 (600) to the face of curb or 6' (1.8 m) to the outside edge of the paved shoulder.

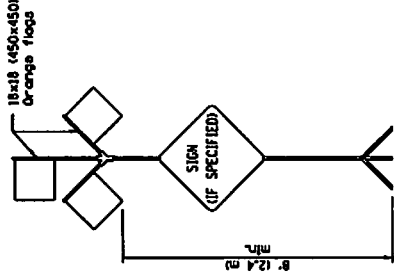

SIGNS ON TEMPORARY SUPPORTS

... When work operations exceed four days, this dimension shall be 5' (1.5 m) min. If located behind other devices, the height shall be sufficient to be seen completely above the devices.

ROAD CONSTRUCTION NEXT X MILES
C20-110401-6036

END CONSTRUCTION
C20-110501-6024

This signing is required for all projects 2 miles (3200 m) or more in length.
ROAD CONSTRUCTION NEXT X MILES sign shall be placed 500' (150 m) in advance of pre-foot limits.
END CONSTRUCTION sign shall be erected at the end of the job unless another job is within 2 miles (3200 m).
Dual sign displays shall be utilized on multi-lane highways.

WORK LIMIT SIGNING

HIGH LEVEL WARNING DEVICE

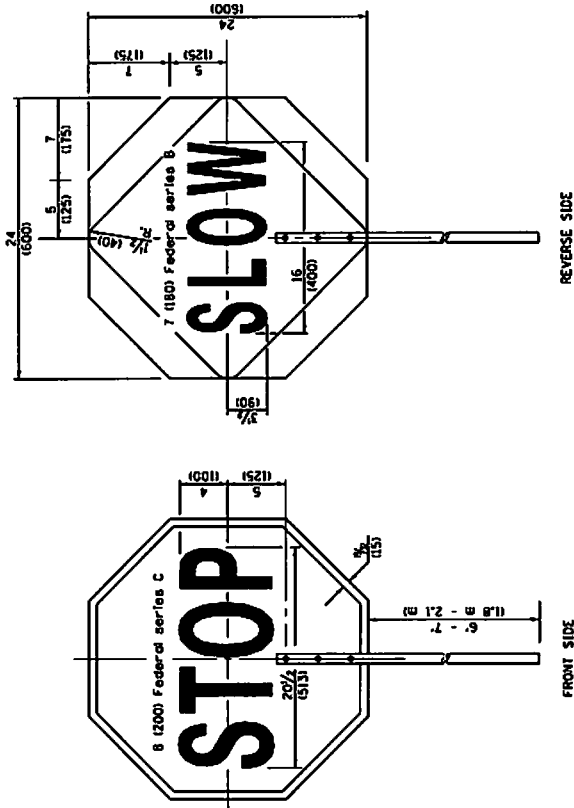

FLAGGER TRAFFIC CONTROL SIGN

Illinois Department of Transportation

APPROVED: _____ PROJECT: _____ 2013

DESIGNED BY: _____

APPROVED: _____ PROJECT: _____ 2013

DESIGNED BY: _____

TRAFFIC CONTROL DEVICES

(Sheet 2 of 3)

STANDARD 701901-04

WORK ZONE SPEED LIMIT XX
W21-12501-3618
R2-1-3648

PHOTO ENFORCED
R10-1108p-3618 ****

\$XXX FINE MINIMUM
R2-1108p-3618

END WORK ZONE SPEED LIMIT
C20-110301-6036

Sign assembly as shown on Standards or as covered by District Operational.

This sign shall be used when the above sign assembly is used.

HIGHWAY CONSTRUCTION SPEED ZONE SIGNS

**** R10-1108p shall only be used along roadways under the jurisdiction of the State.

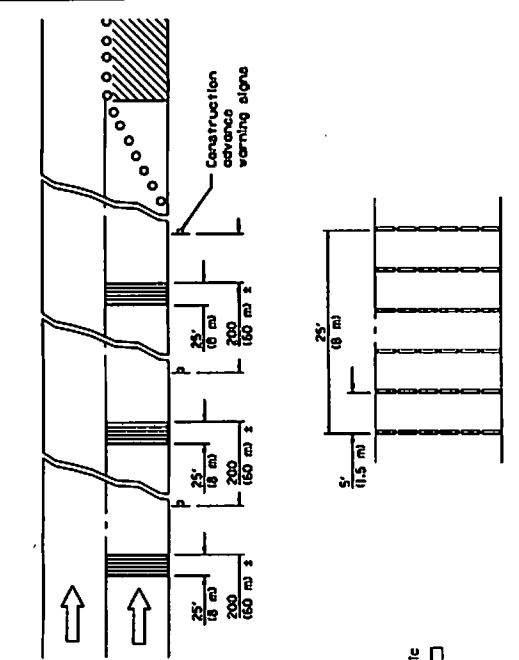

TYPICAL INSTALLATION

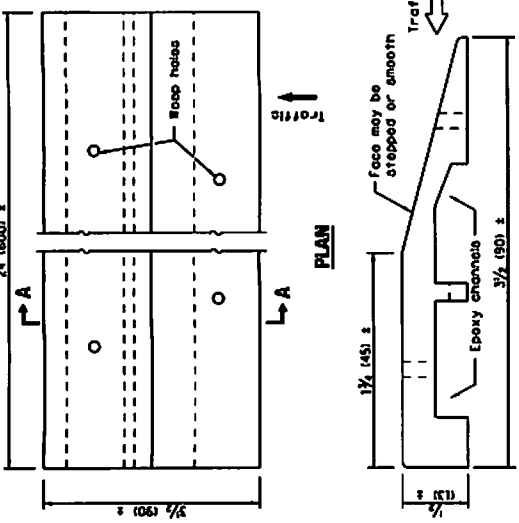

SECTION A-A

TEMPORARY RUMBLE STRIPS

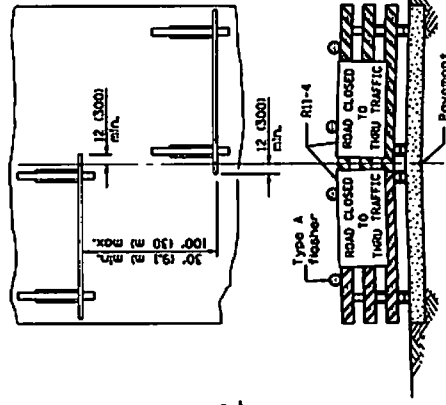

ROAD CLOSED TO THRU TRAFFIC
 ReflectORIZED striping and appear on both sides of the barricade. If a Type III barricade with an attached sign panel which meets MCDOT 350 is used, no signs may be mounted on MCDOT 350 temporary sign supports directly in front of the barricade.

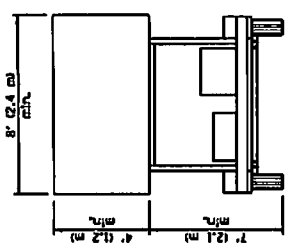

**TYPE C
TRAILER
MOUNTED**

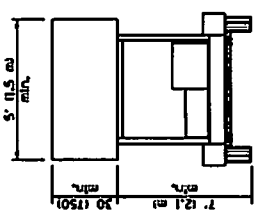

**TYPE B
ROOF OR TRAILER
MOUNTED**

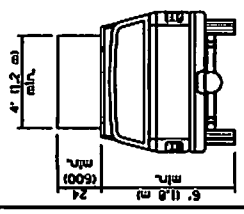

**TYPE A
ROOF
MOUNTED**

ARROW BOARDS

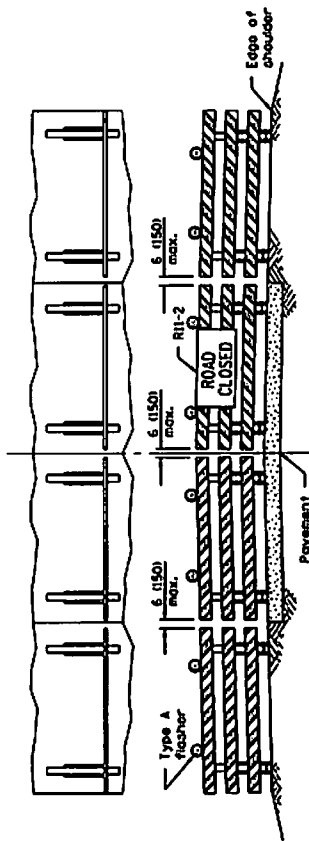

ROAD CLOSED TO ALL TRAFFIC
 ReflectORIZED striping may be omitted on the back side of the barricade. If a Type III barricade with an attached sign panel which meets MCDOT 350 is not available, the sign may be mounted on an MCDOT 350 temporary sign support directly in front of the barricade.

**TYPICAL APPLICATIONS OF
TYPE III BARRICADES CLOSING A ROAD**

Illinois Department of Transportation
 APPROVED: _____ ISSUED: 1-1-97
 PROJECT: _____
 APPROVED: _____

**TRAFFIC CONTROL
DEVICES**

STANDARD 701801-04
 (Sheet 3 of 3)

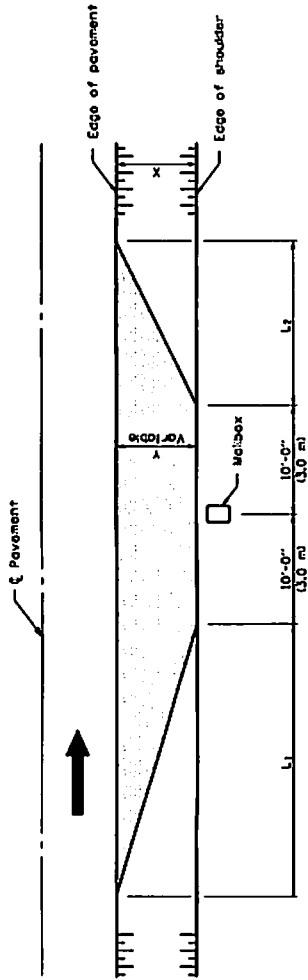

TYPICAL APPLICATION

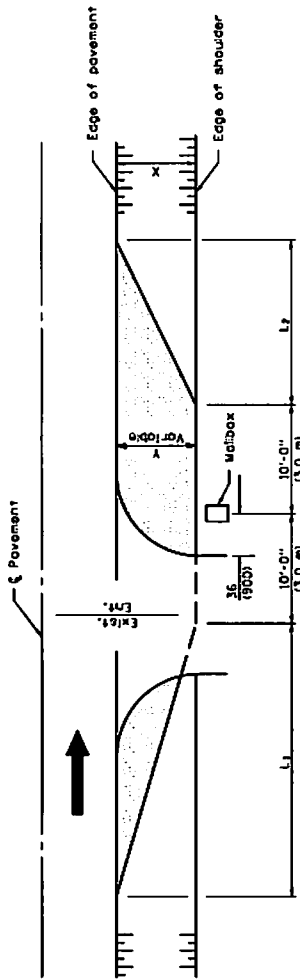

MAILBOX ON FAR SIDE OF ENTRANCE

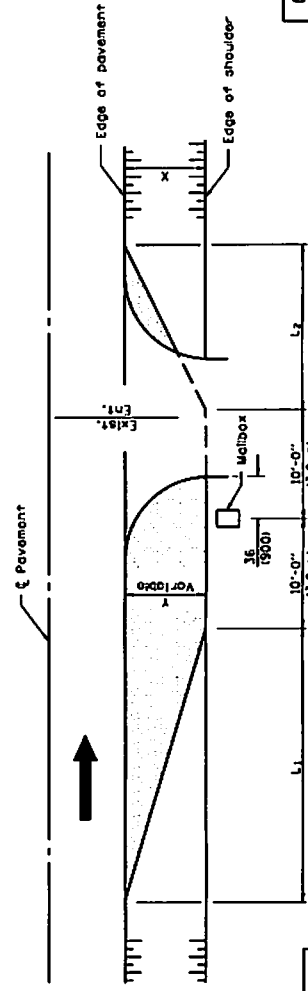

MAILBOX ON NEAR SIDE OF ENTRANCE

DIMENSIONS - ft. (m)

Width of Shoulder (X)	12 (3.6)	10 (3.0)	8 (2.4)	6 (1.8)	5 (1.5)	4 (1.2)
Width of Turnout (Y)	8 (2.4)	6 (1.8)	4 (1.2)	4 (1.2)	4 (1.2)	4 (1.2)
L ₁	30 (9.0)	30 (9.0)	23 (6.9)	15 (4.5)	15 (4.5)	15 (4.5)
L ₂	20 (6.0)	20 (6.0)	15 (4.5)	10 (3.0)	10 (3.0)	10 (3.0)

Note:
Dimensions for Township and District Roads may vary from the above dimensions.

GENERAL NOTES

Mailboxes shall be mounted such that the face of the mailbox is 6 (150) to 12 (300) and the post a minimum of 24 (600) from the edge of the turnout surfacing.

All dimensions are in inches (millimeters) unless otherwise shown.

DATE	REVISIONS
1-1-09	Switched units to English (metric).
1-1-99	Add width of shoulder X.

MAILBOX TURNOUT FOR LOCAL ROADS

STANDARD B.L.R. 24-2

ISSUED 1-1-97

Approved: *[Signature]* 2009
 Director of Highways and Streets
 Approved: *[Signature]* 2009
 Director of Highways and Streets

INDEX
FOR
SUPPLEMENTAL SPECIFICATIONS
AND RECURRING SPECIAL PROVISIONS

Adopted January 1, 2015

This index contains a listing of SUPPLEMENTAL SPECIFICATIONS, frequently used RECURRING SPECIAL PROVISIONS, and LOCAL ROADS AND STREETS RECURRING SPECIAL PROVISIONS.

ERRATA Standard Specifications for Road and Bridge Construction
(Adopted 1-1-12) (Revised 1-1-15)

SUPPLEMENTAL SPECIFICATIONS

<u>Std. Spec. Sec.</u>	<u>Page No.</u>
101 Definition of Terms	1
102 Advertisement, Bidding, Award, and Contract Execution	2
105 Control of Work	3
106 Control of Materials	5
107 Legal Regulations and Responsibility to Public	6
108 Prosecution and Progress	14
109 Measurement and Payment	15
202 Earth and Rock Excavation	17
211 Topsoil and Compost	19
250 Seeding	20
253 Planting Woody Plants	21
280 Temporary Erosion and Sediment Control	23
312 Stabilized Subbase	24
406 Hot-Mix Asphalt Binder and Surface Course	25
407 Hot-Mix Asphalt Pavement (Full-Depth)	28
420 Portland Cement Concrete Pavement	32
424 Portland Cement Concrete Sidewalk	34
440 Removal of Existing Pavement and Appurtenances	35
502 Excavation for Structures	36
503 Concrete Structures	37
504 Precast Concrete Structures	40
506 Cleaning and Painting New Steel Structures	41
512 Piling	42
516 Drilled Shafts	43
521 Bearings	44
540 Box Culverts	45
588 Bridge Relief Joint System	46
589 Elastic Joint Sealer	48
602 Catch Basin, Manhole, Inlet, Drainage Structure, and Valve Vault Construction, Adjustment, and Reconstruction	49
603 Adjusting Frames and Grates of Drainage and Utility Structures	50
606 Concrete Gutter, Curb, Median, and Paved Ditch	52
610 Shoulder Inlets with Curb	53
639 Precast Prestressed Concrete Sight Screen	54
642 Shoulder Rumble Strips	55

643	Impact Attenuators	56
644	High Tension Cable Median Barrier	58
669	Removal and Disposal of Regulated Substances	60
670	Engineer's Field Office and Laboratory	64
701	Work Zone Traffic Control and Protection	65
706	Impact Attenuators, Temporary	68
707	Movable Traffic Barrier	71
708	Temporary Water Filled Barrier	73
730	Wood Sign Support	75
780	Pavement Striping	76
816	Unit Duct	81
836	Pole Foundation	82
860	Master Controller	83
1001	Cement	84
1003	Fine Aggregates	85
1004	Coarse Aggregates	87
1006	Metals	91
1011	Mineral Filler	93
1017	Packaged, Dry, Combined Materials for Mortar	94
1018	Packaged Rapid Hardening Mortar or Concrete	95
1019	Controlled Low-Strength Material (CLSM).....	96
1020	Portland Cement Concrete	97
1024	Grout and Nonshrink Grout	136
1030	Hot-Mix Asphalt	137
1040	Drain Pipe, Tile, Drainage Mat, and Wall Drain	142
1042	Precast Concrete Products	143
1069	Pole and Tower	144
1070	Foundation and Breakaway Devices	145
1073	Controller	146
1081	Materials for Planting	147
1082	Preformed Bearing Pads	148
1083	Elastomeric Bearings	149
1088	Wireway and Conduit System	150
1095	Pavement Markings	152
1101	General Equipment	155
1102	Hot-Mix Asphalt Equipment	157
1103	Portland Cement Concrete Equipment	159
1105	Pavement Marking Equipment	160
1106	Work Zone Traffic Control Devices	161

CHECK SHEET
FOR
RECURRING SPECIAL PROVISIONS

Adopted January 1, 2015

The following RECURRING SPECIAL PROVISIONS indicated by an "X" are applicable to this contract and are included by reference:

<u>CHECK SHEET #</u>	<u>RECURRING SPECIAL PROVISIONS</u>	<u>PAGE NO.</u>
1	<input type="checkbox"/> Additional State Requirements for Federal-Aid Construction Contracts	163
2	<input type="checkbox"/> Subletting of Contracts (Federal-Aid Contracts)	166
3	<input type="checkbox"/> EEO	167
4	<input type="checkbox"/> Specific EEO Responsibilities Non Federal-Aid Contracts	177
5	<input type="checkbox"/> Required Provisions - State Contracts	182
6	<input type="checkbox"/> Asbestos Bearing Pad Removal	188
7	<input type="checkbox"/> Asbestos Waterproofing Membrane and Asbestos Hot-Mix Asphalt Surface Removal	189
8	<input type="checkbox"/> Temporary Stream Crossings and In-Stream Work Pads	190
9	<input type="checkbox"/> Construction Layout Stakes Except for Bridges	191
10	<input type="checkbox"/> Construction Layout Stakes	194
11	<input type="checkbox"/> Use of Geotextile Fabric for Railroad Crossing	197
12	<input type="checkbox"/> Subsealing of Concrete Pavements	199
13	<input type="checkbox"/> Hot-Mix Asphalt Surface Correction	203
14	<input type="checkbox"/> Pavement and Shoulder Resurfacing	205
15	Reserved	206
16	<input type="checkbox"/> Patching with Hot-Mix Asphalt Overlay Removal	207
17	<input type="checkbox"/> Polymer Concrete	208
18	<input type="checkbox"/> PVC Pipeliner	210
19	<input type="checkbox"/> Pipe Underdrains	211
20	<input type="checkbox"/> Guardrail and Barrier Wall Delineation	212
21	<input type="checkbox"/> Bicycle Racks	216
22	Reserved	218
23	<input type="checkbox"/> Temporary Portable Bridge Traffic Signals	219
24	<input type="checkbox"/> Work Zone Public Information Signs	221
25	<input type="checkbox"/> Nighttime Inspection of Roadway Lighting	222
26	<input type="checkbox"/> English Substitution of Metric Bolts	223
27	<input type="checkbox"/> English Substitution of Metric Reinforcement Bars	224
28	<input type="checkbox"/> Calcium Chloride Accelerator for Portland Cement Concrete	225
29	Reserved	226
30	<input type="checkbox"/> Quality Control of Concrete Mixtures at the Plant	227
31	<input type="checkbox"/> Quality Control/Quality Assurance of Concrete Mixtures	235
32	<input type="checkbox"/> Digital Terrain Modeling for Earthwork Calculations	251
33	<input type="checkbox"/> Pavement Marking Removal	253
34	<input type="checkbox"/> Preventive Maintenance – Bituminous Surface Treatment	254
35	<input type="checkbox"/> Preventive Maintenance – Cape Seal	260
36	<input type="checkbox"/> Preventive Maintenance – Micro-Surfacing	275
37	<input type="checkbox"/> Preventive Maintenance – Slurry Seal	286
38	<input type="checkbox"/> Temporary Raised Pavement Markers	296
39	<input type="checkbox"/> Restoring Bridge Approach Pavements Using High-Density Foam	297

CHECK SHEET
FOR
LOCAL ROADS AND STREETS RECURRING SPECIAL PROVISIONS

Adopted January 1, 2015

The following LOCAL ROADS AND STREETS RECURRING SPECIAL PROVISIONS indicated by an "X" are applicable to this contract and are included by reference:

LOCAL ROADS AND STREETS RECURRING SPECIAL PROVISIONS

<u>CHECK SHEET #</u>	<u>PAGE NO.</u>
LRS 1	Reserved..... 301
LRS 2	<input type="checkbox"/> Furnished Excavation 302
LRS 3	<input type="checkbox"/> Work Zone Traffic Control Surveillance 303
LRS 4	<input type="checkbox"/> Flaggers in Work Zones 304
LRS 5	<input type="checkbox"/> Contract Claims 305
LRS 6	<input type="checkbox"/> Bidding Requirements and Conditions for Contract Proposals 306
LRS 7	<input type="checkbox"/> Bidding Requirements and Conditions for Material Proposals 312
LRS 8	Reserved..... 318
LRS 9	<input type="checkbox"/> Bituminous Surface Treatments 319
LRS 10	Reserved..... 320
LRS 11	<input type="checkbox"/> Employment Practices 321
LRS 12	<input type="checkbox"/> Wages of Employees on Public Works 323
LRS 13	<input type="checkbox"/> Selection of Labor 325
LRS 14	<input type="checkbox"/> Paving Brick and Concrete Paver Pavements and Sidewalks 326
LRS 15	<input type="checkbox"/> Partial Payments 329
LRS 16	<input type="checkbox"/> Protests on Local Lettings 330
LRS 17	<input type="checkbox"/> Substance Abuse Prevention Program 331
LRS 18	<input type="checkbox"/> Multigrade Cold Mix Asphalt 332

INDEX OF SPECIAL PROVISIONS

Page	Title
1	DESCRIPTION OF WORK
1	HOT-MIX ASPHALT SURFACE REMOVAL - BUTT JOINT
1	LEVELING BINDER (MACHINE METHOD), IL-9.5FG, N50
1	HOT-MIX ASPHALT SURFACE COUSRE, MIX "C", N50
2	HOT-MIX ASPHALT SHOULDERS, SPECIAL
2	TRAFFIC CONTROL
2	SHORT TERM PAVEMENT MARKING
3	PROSECUTION OF WORK
3	PREVAILING WAGE
3	MOBILIZATION
3	COMPLETION DATE



Special Provisions

The following Special Provisions supplement the "Standard Specifications for Road and Bridge Construction", Adopted January 1, 2012, the latest edition of the "Manual on Uniform Traffic Control Devices for Streets and Highways", and the "Manual of Test Procedures of Materials" in effect on the date of invitation of bids, and the Supplemental Specifications and Recurring Special Provisions indicated on the Check Sheet included here in which apply to and govern the construction of Section 09-00236-00-RS, DeKalb County, and in case of conflict with any part, or parts, of said Specifications, the said Special Provisions shall take precedence and shall govern.

DESCRIPTION OF WORK The work of this section shall consist of placing a 1" lift of Leveling Binder (Machine Method), IL-9.5FG, N50 and a 1 1/4" lift of Hot-Mix Asphalt Surface Course, Mixture C, N50, Hot-Mix Asphalt Shoulders, and other incidental work on Chicago Road from Maplewood Road to Somonauk Road, a distance of 4.56 miles.

HOT-MIX ASPHALT SURFACE REMOVAL – BUTT JOINT This work shall be done in accordance with **Section 406.08** of the Standard Specifications. The work shall consist of milling the existing pavement at various locations throughout the project.

The Butt Joints at the sideroads of Graham Road, Howison Road, Governor Beveridge Highway, and the east project limit at Somonauk shall be 1 1/4" deep tapered to 0" over 25 feet.

The Butt Joints at the west end of the project shall be 1 1/4" deep tapered to 0" over 50 feet.

The Butt Joints at the right of way of entrances shall be 1 1/4" deep tapered to 0" over 6 feet.

Any and all Temporary Ramps required by the Engineer as per Article 406.08 will be considered incidental to this pay item.

Method of Measurement - Only that portion of the pavement that has been milled to a minimum depth of 1/4" will be measured for payment. This work, including all milling, hauling and disposal of the millings shall be paid for at the contract unit price per square yard for Hot-Mix Asphalt Surface Removal – Butt Joint.

LEVELING BINDER (MACHINE METHOD), IL-9.5FG, N50 This work shall be performed in accordance with **Section 406 and 1030** of the Standard Specifications with the following exceptions:

Article 406.14 Basis of Payment - This work shall be paid for at the contract unit price per ton for Bituminous Materials (Prime Coat). Leveling Binder (Machine Method), N50 shall include Quality Control as per **Section 1030**.

PG Grade PG 64-22

Design Air Voids 4%

Mixture Composition IL 9.5 FG

Quantities are estimates prepared for the establishment of pay item prices and are the responsibility of the contractor to confirm prior to bidding. Quantities may be increased, decreased, or omitted to satisfactorily complete the project.

HOT-MIX ASPHALT SURFACE COURSE, MIXTURE C, N50 This work shall be done in accordance with **Section 406 and 1030** of the Standard Specifications with the following exceptions:

Article 406.05 Preparation, Priming, and Leveling of HMA -The bituminous materials shall be SS-1 and applied per Hot Mix Asphalt – Prime Coat (BDE) or to the satisfaction of the Engineer prior to placement of the Hot-Mix Asphalt Surface Course, Mixture C, N50.

Article 406.07 Compaction - (c) Density 1030.05 d. (3) Required Field Tests – Use LR 1030 "Special Provision for Growth Curve" included in this proposal.

Article 406.14 Basis of Payment - This work shall be paid for at the contract unit price per ton for Hot-Mix Asphalt Surface Course, Mixture C, N50 which price shall include Quality Control as per Section 1030 and all the work specified in this Special Provision.

PG Grade PG 64-22

Design Air Voids 4% at N50

Mixture Composition IL 9.5

Friction Aggregate Mixture C

Quantities are estimates prepared for the establishment of pay item prices and are the responsibility of the contractor to confirm prior to bidding. Quantities may be increased, decreased, or omitted to satisfactorily complete the project.

HOT-MIX ASPHALT SHOULDERS, SPECIAL This work shall consist of the placement of 3 lifts of hot-mix asphalt in a 3 ft wide shoulder. The first lift shall have a compacted thickness of 3" and shall be placed and compacted by the contractor in a trench prepared by others. The trench excavation for the paved shoulder will be completed by others immediately ahead of the contractor's operations. The second lift and third lift shall be placed and compacted at the same thickness and time as the mainline pavement.

The cost of preparing the trench for shoulder paving will not be included in the contract. The priming of the base prior to placing the first lift of the asphalt shoulder shall be MC-30 and shall be paid at the contract unit price per pound for BITUMINOUS MATERIAL (PRIME COAT). The placement of the bottom lift of asphalt shoulder (lowest 3") shall be paid at the contract unit price per Ton for HOT-MIX ASPHALT SHOULDER SPECIAL, SPECIAL. The placement of the middle lift of asphalt shoulder (middle 1") shall be paid at the contract unit price per Ton for LEVELING BINDER, MACHINE METHOD, N50. The placement of the top lift of asphalt shoulder (top 1 1/4") shall be paid at the contract unit price per Ton for HOT-MIX ASPHALT SURFACE COURSE, MIX C, N50.

HOT-MIX ASPHALT SHOULDERS, SPECIAL

PG Grade	PG 64-22
Design Air Voids	4% at N50
Mixture Composition	IL 19.0FG
Friction Aggregate	n/a

TRAFFIC CONTROL Traffic Control shall be in accordance with the applicable sections of the Standard Specifications for Road and Bridge Construction, the applicable guidelines contained in the manual on Uniform Traffic Control Devices for Streets and Highways, these Special Provisions, and any special details and Highway Standards contained herein and in the plans.

Standards 701201, 701301, 701306, 701901, 780001, BLR 24-2.

The entire section shall remain open to a minimum of one lane of traffic each direction during construction. After hours of operation each day, the contractor shall open all lanes to overnight traffic.

The presence of temporary traffic control drawings or standards in the project plans, whether a pay item or not, does not relieve the contractor of his obligation to the public, in accordance with **Article 107.14** of the Standard Specifications for Road and Bridge Construction. The contractor shall provide, to the satisfaction of the Engineer, all protection deemed necessary beyond that shown in the plans or Special Provisions.

"BUMP" signs shall be installed as directed by the Engineer.

"LOW SHOULDER" signs shall be installed at 2 mile intervals or as directed by the Engineer.

"UNEVEN LANES" signs shall be installed at 2 mile intervals or as directed by the Engineer.

Flaggers shall comply with all requirements contained in the Department's "Flagger Handbook" with the following exception: The ANSI Class 2 vest will not be supplied by the Department.

The cost of any and all traffic control required by these special provisions and the standards included in this proposal shall be considered incidental to the contract.

SHORT TERM PAVEMENT MARKING This work shall be done in accordance with **Section 703** of the Standard Specifications with the following exceptions:

Article 703.04 - The short term pavement marking tape shall be removed within 5 days after the permanent pavement markings have been installed. This work shall be considered incidental to this pay item.

Article 703.07 – Basis of Payment – This work shall be paid for at the contract unit price per foot for SHORT TERM PAVEMENT MARKING.

PROSECUTION OF WORK The Contractor shall notify the Engineer a minimum of two (2) working days (i.e. notice given on Thursday A.M. for work to begin the following Monday) prior to commencement of any work which would be considered as a pay item in the contract. No payment will be made to the Contractor for any pay item work performed without the aforementioned notice being given unless otherwise approved by the Engineer. Work shall be performed between sunrise and sunset only.

PREVAILING WAGE The Contractor(s) shall pay prevailing wage to employees on this project in accordance with LR107-7. The Contractor shall be responsible for obtaining the monthly rate sheet from the Illinois Department of Labor. These sheets are also available at the DeKalb County Clerk's office or at:
<http://www.illinois.gov/idol/Laws-Rules/CONMED/Pages/Rates.aspx>

MOBILIZATION This contract contains no provision for mobilization, therefore **section 671** of the standard specifications is deleted.

COMPLETION DATE This work shall be completed by October 16, 2015.

State of Illinois
Department of Transportation
Bureau of Local Roads and Streets

SPECIAL PROVISION
FOR
INSURANCE

Effective: February 1, 2007
Revised: August 1, 2007

All references to Sections or Articles in this specification shall be construed to mean specific Section or Article of the Standard Specifications for Road and Bridge Construction, adopted by the Department of Transportation.

The Contractor shall name the following entities as additional insured under the Contractor's general liability insurance policy in accordance with Article 107.27:

The entities listed above and their officers, employees, and agents shall be indemnified and held harmless in accordance with Article 107.26.

State of Illinois
DEPARTMENT OF TRANSPORTATION
Bureau of Local Roads & Streets

SPECIAL PROVISION
FOR
GROWTH CURVE

Effective: March 1, 2008
Revised: January 1, 2010

All references to Sections and Articles in this Special Provision shall be construed to mean specific Sections and Articles in the Standard Specifications for Road and Bridge Construction adopted by the Department of Transportation.

The Contractor shall perform a growth curve at the beginning of placement of each type of mix and each lift. The growth curve for each type of mix and each lift shall be performed within the first 200 tons (180 metric tons). If an adjustment is made to the specific mix design, the Engineer reserves the right to request an additional growth curve and supporting tests at the Contractor's expense.

Compaction of the growth curve shall commence immediately after the course is placed and at a temperature of not less than 280 °F (140 °C). The growth curve, consisting of a plot of lb/cu ft (kg/cu m) vs. number of passes with the project breakdown roller, shall be developed. Roller speed during the growth curve testing shall be the same as the normal paving operation. This curve shall be established by use of a nuclear gauge. Tests shall be taken after each pass until the highest lb/cu ft (kg/cu m) is obtained. This value shall be the target density provided the HMA Gyratory air voids are within acceptable limits. If the HMA Gyratory air voids are not within the specified limits, corrective action shall be taken, and a new target density shall be established.

A new growth curve is required if the breakdown roller used on the growth curve is replaced with a new roller during production. The target density shall apply only to the specific gauge used. If additional gauges are to be used to determine density specification compliance, the Contractor shall establish a unique minimum allowable target density from the growth curve location for each gauge.

At least one core sample per day shall be taken at a location specified by the Engineer. Core densities will be determined using the Illinois-Modified AASHTO T 166 or T 275 procedure by the Department. The core density shall be according to Articles 1030.05(d)(4) and (d)(7). The QA Manager is responsible for assuring and documenting that the determined number of roller passes has been accomplished. The Engineer reserves the right to take core samples at any time to verify density from the nuclear gauge,

All lifts and confined longitudinal joint edges shall be compacted to an average nuclear gauge density of not less than 95 percent nor greater than 102 percent of the target density obtained on the growth curve. Unconfined longitudinal joint edges shall be compacted to an average nuclear gauge density of not less than 93 percent nor greater than 102 percent of the target density obtained on the growth curve. The average nuclear gauge density shall be based on tests representing one day's production.

Quality Control density tests shall be performed at randomly selected locations within 1/2 mile (800 m) intervals per lift per lane. In no case shall more than one half day's production be completed without density testing being performed. Longitudinal joint density testing shall be performed at each random density test location. Longitudinal joint testing shall be located at a distance equal to the lift thickness or a minimum of 2 in. (50 mm) from each pavement edge.

If the Contractor is not controlling the compaction process and is making no effort to take corrective action, the operation shall stop as directed by the Engineer.

State of Illinois
DEPARTMENT OF TRANSPORTATION
Bureau of Local Roads & Streets

SPECIAL PROVISION
FOR
EMULSIFIED ASPHALTS

Effective: January 1, 2007
Revised: February 7, 2008

All references to Sections and Articles in this Special Provision shall be construed to mean specific Sections and Articles in the Standard Specifications for Road and Bridge Construction adopted by the Department of Transportation.

Replace the table after Note 2 in Article 403.02 with the following:

Type of Construction	Bituminous Materials Recommended for Weather Conditions Indicated	
	Warm [15 °C to 30 °C]* [(60 °F to 85 °F)]*	Hot [30 °C Plus]* [(85 °F Plus)]*
Prime	MC-30, PEP	MC-30, PEP
Cover Coat and Seal Coat	RS-2, CRS-2, RC-800, RC-3000, MC-800, MC-3000, SC-3000, HFE-90, HFE-150, HFE-300, HFRS-2, PEA**	RS-2, CRS-2, RC-800, RC-3000, MC-800, MC-3000, SC-3000, PG46-28, PG52-28, HFE-90, HFE-150, HFE-300, HFRS-2, PEA**

* Temperature of the air in the shade at the time of application.

** PEA is only allowed on roads with low traffic volumes

Replace the table after Note 2 in Article 406.02 with the following:

Type of Construction	Bituminous Materials Recommended
Prime (tack) on Brick, Concrete, or Bituminous Bases (Note 3)	SS-1, SS-1h, CSS-1, CSS-1h, HFE-90, RC-70
Prime on Aggregate Bases (Note 4)	MC-30, PEP
Mixture for Cracks, Joints, and Flangeways	PG58-22, PG64-22

Note 3. When emulsified asphalts are used, they shall be diluted with an equal volume of potable water. HFE emulsions shall be diluted by the manufacturer. The diluted material shall be thoroughly agitated within 24 hours of application and show no separation of water and emulsion. The diluted material shall not be returned to an approved emulsion storage tank.

Note 4. Preparation of the bituminous PEP shall be as specified in Article 403.05.

Replace the table in Article 1032.04 with the following:

Spraying Application Temperature Ranges		
Type and Grade of Bituminous Material	Temperature Ranges	
	°F min. - max.	°C min. - max.
PEP	60 - 130	15 - 55
PEA	140 - 190	60 - 88
MC-30	85 - 190	30 - 90
MC-70, RC-70, SC-70	120 - 225	50 - 105
MC-250, SC-250	165 - 270	75 - 130
MC-800, SC-800	200 - 305	95 - 150
MC-3000, SC-3000	230 - 345	110 - 175
PG46-28	275 - 385	135 - 195
PG52-28	285 - 395	140 - 200
RS-2, CRS-2	110 - 160	45 - 70
SS-1, SS-1h, CSS-1, CSS-1h	75 - 130	25 - 55
SS-1hP, CSS-1hP	75 - 130	25 - 55
HFE-90, HFE-150, HFE-300	150 - 180	65 - 80
HFP, CRSP, HFRS-2	150 - 180	65 - 80
E-2	85 - 190	30 - 90
E-3	120 - 225	50 - 105
E-4	165 - 270	75 - 130

Add subparagraph (g) to Article 1032.06:

- (g) Penetrating Emulsified Asphalt (PEA). The penetrating emulsified asphalt shall meet the following requirements when tested according to AASHTO T59:

Viscosity, Saybolt Fural @ 25°C (77°F),	sec:	20 - 500
Sieve Test, retained on 850 μm (No. 20) sieve, maximum,	%:	0.10
Storage Stability Test, 1 day, maximum,	%:	1
Float Test @ 60°C (140°F), minimum,	sec:	150
Stone Coating Test, 3 minutes,	:	Stone Coated Thoroughly
Particle Charge	:	Negative
pH, minimum	:	7.3
Distillation Test:		
Distillation to 260°C (500°F) Residue, minimum	%:	65
Oil Distillate by Volume, maximum	%:	3
Test on residue from distillation:		
Penetration @ 25°C (77°F), 100 g, 5 sec, minimum	dmm:	300

Replace the last sentence and table of Article 1032.06 with the following:

The different grades are, in general, used for the following.

Grade	Use
SS-1, SS-1h, CSS-1, CSS-1h, HFE 90, SS-1hP, CSS-1hP	Tack or fog seal
PEP	Bituminous surface treatment prime
RS-2, HFE 90, HFE 150, HFE 300, CRSP, HFP, CRS-2, HFRS-2, PEA	Bituminous surface treatment
CSS-1h Latex Modified	Microsurfacing

HOT-MIX ASPHALT MIXTURE IL-9.5FG (BMPR)

Effective: July 1, 2005

Revised: December 28, 2010

Description. This work shall consist of constructing fine graded hot-mix asphalt (HMA) surface course or leveling binder with an IL-9.5FG mixture. Work shall be according to Sections 406, 407 and 1030 of the Standard Specifications, except as modified herein.

Materials. Revise Article 1003.03(c) of the Standard Specifications to read:

- “(c) Gradation. The fine aggregate gradation for all HMA shall be FA 1, FA 2, FA 20, or FA 21. For mixture IL-9.5FG, the fine aggregate fraction shall consist of at least 67 percent manufactured sand meeting FA 20 gradation. The manufactured sand shall be stone sand, slag sand, steel slag sand, or combinations thereof.”

Mixture Design. Add the following to the table in Article 1030.04(a)(1):

“High ESAL, MIXTURE COMPOSITION (% PASSING) ^{1/}		
Sieve Size	IL-9.5FG	
	min	max
1 1/2 in (37.5 mm)		
1 in. (25 mm)		
3/4 in. (19 mm)		
1/2 in. (12.5 mm)		100
3/8 in. (9.5 mm)	90	100
#4 (4.75 mm)	60 ^{4/}	75 ^{4/}
#8 (2.36 mm)	45 ^{4/}	60 ^{4/}
#16 (1.18 mm)	25	40
#30 (600 μm)	15	30
#50 (300 μm)	8	15
#100 (150 μm)	6	10
#200 (75 μm)	4	6.5
Ratio Dust/Asphalt Binder		1.0

4/ When used as level binder placed less than 1 in. (25 mm) thick, the min and max percent passing shall each be increased 5%.

Revise the table in Article 1030.04(b)(1) of the Standard Specifications to read:

“VOLUMETRIC REQUIREMENTS High ESAL					
	Voids in the Mineral Aggregate (VMA), % minimum				Voids Filled with Asphalt Binder (VFA), %
N _{design}	IL-25.0	IL-19.0	IL-12.5	IL-9.5	
50	12.0	13.0	14.0	15 ^{1/}	65 - 78
70					
90					
105					65 - 75 ^{2/}

1/ The VMA for IL-9.5FG shall be a minimum of 15.0 percent.

2/ The VFA range for IL-9.5FG shall be 65 - 78 percent.”

Quality Control/Quality Assurance (QC/QA). Revise the second table in Article 1030.05(d)(4) to read:

DENSITY CONTROL LIMITS			
Mixture Composition		Parameter	Individual Test ^{3/}
IL-9.5FG	Lifts < 1.25 in. (32 mm)	N _{design} 50 - 105	91.0 – 97.0% ^{2/}
	Lifts ≥ 1.25 in. (32 mm)	N _{design} 50 - 105	93.0 – 97.0%
IL-9.5, IL-12.5		N _{design} ≥ 90	92.0 – 96.0 %
IL-9.5, IL-9.5L, IL-12.5		N _{design} < 90	92.5 – 97.4 %
IL-19.0, IL-25.0		N _{design} ≥ 90	93.0 – 96.0 %
IL-19.0, IL-19.0L, IL-25.0		N _{design} < 90	93.0 – 97.4 %
All Other		N _{design} = 30	93.0 ^{1/} - 97.4 %

1/ 92.0 % when placed as first lift on an unimproved subgrade.

2/ Density shall be determined by cores or by correlated, approved thin lift nuclear gauge.

3/ Bulk Specific Gravity and Density that are determined using coated samples must be in accordance with ASTM 1188-96.

CONSTRUCTION REQUIREMENTS

Leveling Binder. Revise the table and second paragraph of Article 406.05(c) of the Standard Specifications to read:

"Leveling Binder	
Nominal, Compacted, Leveling Binder Thickness, in. (mm)	Mixture Composition
≤ 1 1/4 (32)	IL-9.5, IL-9.5 FG, or IL-9.5L
> 1 1/4 to 2 (32 to 50)	IL-9.5, IL-9.5FG, IL-9.5L, or IL-12.5

The density requirements of Article 1030.05(d)(4) shall apply for leveling binder, machine method, when the nominal, compacted thickness is: 3/4 in. (19 mm) or greater for IL-9.5FG mixtures, 1 1/4 in. (32 mm) or greater for IL-9.5 and IL-9.5L mixtures, and 1 1/2 in. (38 mm) or greater for IL-12.5 mixtures."

Compaction. Revise Table 1 in Article 406.07(a) of the Standard Specifications to read:

"TABLE 1 - MINIMUM ROLLER REQUIREMENTS FOR HMA				
	Breakdown Roller (one of the following)	Intermediate Roller	Final Roller (one or more of the following)	Density Requirement
Level Binder: (When the density requirements of Article 406.05(c) do not apply.)	P 3/	--	VS, P 3/, TB, TF, 3W	To the satisfaction of the Engineer.
Level Binder: (When placed at ≤ 1 ¼ (32 mm) and density requirements apply.)	TB, 3W	P 3/	VS, TB, TF	As specified in Articles: 1030.05(d)(3), (d)(4), and (d)(7).

Binder and Surface 1/ (When the density requirements of Article 406.05(c) apply.)	VD, P 3/, TB, 3W	P 3/	VS, TB, TF	As specified in Articles: 1030.05(d)(3), (d)(4), and (d)(7).
Bridge Decks 2/	TB	- -	TF	As specified in Articles: 582.05 and 582.06.

- 1/ If the average delivery at the job site is 85 ton/hr (75 metric ton/hr) or less, any roller combination may be used provided it includes a steel wheeled roller and the required density and smoothness is obtained.
- 2/ One TB may be used for both breakdown and final rolling on bridge decks 300 ft (90 m) or less in length, except when the air temperature is less than 60 °F (15 °C).
- 3/ A vibratory roller (VD) may be used in lieu of the pneumatic-tired roller on mixtures containing polymer modified asphalt binder.

Basis of Payment. Add the following two paragraphs after the third paragraph of Article 406.14 of the Standard Specifications:

"Mixture IL-9.5FG will be paid for at the contract unit price per ton (metric ton) for LEVELING BINDER (HAND METHOD), IL-9.5FG, of the Ndesign specified; LEVELING BINDER (MACHINE METHOD), IL-9.5FG, of the Ndesign specified; or HOT-MIX ASPHALT SURFACE COURSE, IL-9.5FG, of the Ndesign specified.

Mixture IL-9.5FG in which polymer modified asphalt binders are required will be paid for at the contract unit price per ton (metric ton) for POLYMERIZED LEVELING BINDER (HAND METHOD), IL-9.5FG, of the Ndesign specified; POLYMERIZED LEVELING BINDER (MACHINE METHOD), IL-9.5FG, of the Ndesign specified; or POLYMERIZED HOT-MIX ASPHALT SURFACE COURSE, IL-9.5FG, of the Ndesign specified."

De Kalb County Prevailing Wage for February 2015

(See explanation of column headings at bottom of wages)

Trade Name	RG	TYP	C	Base	FRMAN	M-F>8	OSA	OSH	H/W	Pensn	Vac	Trng
=====	==	===	=	=====	=====	=====	===	===	=====	=====	=====	=====
ASBESTOS ABT-GEN		BLD		31.130	32.130	1.5	1.5	2.0	8.240	14.14	0.000	0.800
ASBESTOS ABT-MEC		BLD		35.100	37.600	1.5	1.5	2.0	11.17	10.76	0.000	0.720
BOILERMAKER		BLD		44.240	48.220	2.0	2.0	2.0	6.970	17.54	0.000	0.350
BRICK MASON		BLD		42.580	46.840	1.5	1.5	2.0	9.850	13.60	0.000	1.030
CARPENTER		BLD		38.240	42.450	1.5	1.5	2.0	9.440	14.95	0.000	0.600
CARPENTER		HWY		37.230	38.980	1.5	1.5	2.0	11.00	14.00	0.000	0.490
CEMENT MASON		ALL		42.900	44.900	2.0	1.5	2.0	9.900	16.32	0.000	0.500
CERAMIC TILE FNSHER		BLD		35.810	0.000	1.5	1.5	2.0	10.55	8.440	0.000	0.710
COMMUNICATION TECH		BLD		36.440	40.080	1.5	1.5	2.0	10.39	12.09	0.000	0.760
ELECTRIC PWR EQMT OP		ALL		37.890	51.480	1.5	1.5	2.0	5.000	11.75	0.000	0.380
ELECTRIC PWR GRNDMAN		ALL		29.300	51.480	1.5	1.5	2.0	5.000	9.090	0.000	0.290
ELECTRIC PWR LINEMAN		ALL		45.360	51.480	1.5	1.5	2.0	5.000	14.06	0.000	0.450
ELECTRIC PWR TRK DRV		ALL		30.340	51.480	1.5	1.5	2.0	5.000	9.400	0.000	0.300
ELECTRICIAN		BLD		42.960	47.260	1.5	1.5	2.0	10.39	17.47	0.000	0.860
ELEVATOR CONSTRUCTOR		BLD		46.830	52.680	2.0	2.0	2.0	13.57	14.21	3.750	0.600
FENCE ERECTOR	SE	ALL		45.060	48.660	2.0	2.0	2.0	10.52	18.81	0.000	0.400
GLAZIER		BLD		35.980	37.980	1.5	1.5	1.5	10.30	8.200	0.000	1.250
HT/FROST INSULATOR		BLD		48.450	50.950	1.5	1.5	2.0	11.47	12.16	0.000	0.720
IRON WORKER	NW	ALL		36.290	38.100	2.0	2.0	2.0	8.640	22.69	0.000	0.500
IRON WORKER	SE	ALL		45.060	48.660	2.0	2.0	2.0	10.52	18.81	0.000	0.400
LABORER		BLD		31.130	32.130	1.5	1.5	2.0	8.240	14.14	0.000	0.800
LABORER		HWY		33.560	34.310	1.5	1.5	2.0	8.240	16.39	0.000	0.800
LABORER, SKILLED		HWY		36.160	36.910	1.5	1.5	2.0	8.240	16.39	0.000	0.800
LATHER		BLD		38.240	42.450	1.5	1.5	2.0	9.440	14.95	0.000	0.600
MACHINIST		BLD		44.350	46.850	1.5	1.5	2.0	6.760	8.950	1.850	0.000
MARBLE MASON		BLD		41.780	45.960	1.5	1.5	2.0	9.850	13.42	0.000	0.760
MATERIAL TESTER I		ALL		33.560	0.000	1.5	1.5	2.0	8.240	16.39	0.000	0.800
MATERIALS TESTER II		ALL		33.560	0.000	1.5	1.5	2.0	8.240	16.39	0.000	0.800
MILLWRIGHT		BLD		36.120	39.730	1.5	1.5	2.0	9.420	14.30	0.000	0.500
OPERATING ENGINEER		BLD 1		42.800	46.800	2.0	2.0	2.0	17.10	11.05	2.350	1.300
OPERATING ENGINEER		BLD 2		42.100	46.800	2.0	2.0	2.0	17.10	11.05	2.350	1.300
OPERATING ENGINEER		BLD 3		39.650	46.800	2.0	2.0	2.0	17.10	11.05	2.350	1.300
OPERATING ENGINEER		BLD 4		37.650	46.800	2.0	2.0	2.0	17.10	11.05	2.350	1.300
OPERATING ENGINEER		BLD 5		46.550	46.800	2.0	2.0	2.0	17.10	11.05	2.350	1.300
OPERATING ENGINEER		BLD 6		45.800	46.800	2.0	2.0	2.0	17.10	11.05	0.000	1.300
OPERATING ENGINEER		BLD 7		42.800	46.800	2.0	2.0	2.0	17.10	11.05	0.000	1.300
OPERATING ENGINEER		HWY 1		42.650	46.650	1.5	1.5	2.0	17.10	11.05	2.350	1.300
OPERATING ENGINEER		HWY 2		42.100	46.650	1.5	1.5	2.0	17.10	11.05	2.350	1.300
OPERATING ENGINEER		HWY 3		40.800	46.650	1.5	1.5	2.0	17.10	11.05	2.350	1.300
OPERATING ENGINEER		HWY 4		39.350	46.650	1.5	1.5	2.0	17.10	11.05	2.350	1.300
OPERATING ENGINEER		HWY 5		37.900	46.650	1.5	1.5	2.0	17.10	11.05	2.350	1.300
OPERATING ENGINEER		HWY 6		45.650	46.650	1.5	1.5	2.0	17.10	11.05	2.350	1.300
OPERATING ENGINEER		HWY 7		45.650	46.650	1.5	1.5	2.0	17.10	11.05	2.350	1.300
ORNAMNTL IRON WORKER	SE	ALL		45.060	48.660	2.0	2.0	2.0	10.52	18.81	0.000	0.400
PAINTER		ALL		41.730	43.730	1.5	1.5	1.5	10.30	8.200	0.000	1.350
PAINTER SIGNS		BLD		33.920	38.090	1.5	1.5	1.5	2.600	2.710	0.000	0.000
PILEDRIIVER		BLD		38.240	42.450	1.5	1.5	2.0	9.440	14.95	0.000	0.600
PILEDRIIVER		HWY		37.230	38.980	1.5	1.5	2.0	11.00	14.00	0.000	0.490
PIPEFITTER		BLD		46.000	49.000	1.5	1.5	2.0	9.000	15.85	0.000	1.780
PLASTERER		BLD		42.250	44.790	1.5	1.5	2.0	11.40	12.19	0.000	0.650
PLUMBER		BLD		46.650	48.650	1.5	1.5	2.0	13.18	11.46	0.000	0.880
ROOFER		BLD		40.100	43.100	1.5	1.5	2.0	8.280	10.54	0.000	0.530
SHEETMETAL WORKER		BLD		37.930	40.210	1.5	1.5	2.0	6.000	16.92	0.520	0.290
SPRINKLER FITTER		BLD		37.120	39.870	1.5	1.5	2.0	8.420	8.500	0.000	0.350
STEEL ERECTOR	SE	ALL		45.060	48.660	2.0	2.0	2.0	10.52	18.81	0.000	0.400
STONE MASON		BLD		42.580	46.840	1.5	1.5	2.0	9.850	13.60	0.000	1.030
SURVEY WORKER	---	NOT IN EFFECT				ALL	35.650	36.400	1.5	1.5	2.0	8.240 13.95 0.000 0.800
TERRAZZO FINISHER		BLD		37.040	0.000	1.5	1.5	2.0	10.55	10.32	0.000	0.620
TERRAZZO MASON		BLD		40.880	43.880	1.5	1.5	2.0	10.55	11.63	0.000	0.820
TILE LAYER		BLD		38.240	42.450	1.5	1.5	2.0	9.440	14.95	0.000	0.600
TILE MASON		BLD		42.840	46.840	1.5	1.5	2.0	10.55	10.42	0.000	0.920
TRUCK DRIVER		ALL 1		32.550	33.100	1.5	1.5	2.0	6.500	4.350	0.000	0.000
TRUCK DRIVER		ALL 2		32.700	33.100	1.5	1.5	2.0	6.500	4.350	0.000	0.000
TRUCK DRIVER		ALL 3		32.900	33.100	1.5	1.5	2.0	6.500	4.350	0.000	0.000
TRUCK DRIVER		ALL 4		33.100	33.100	1.5	1.5	2.0	6.500	4.350	0.000	0.000
TUCKPONTER		BLD		42.800	43.800	1.5	1.5	2.0	8.180	12.66	0.000	0.650

Legend: RG (Region)
 TYP (Trade Type - All, Highway, Building, Floating, Oil & Chip, Rivers)
 C (Class)
 Base (Base Wage Rate)
 FRMAN (Foreman Rate)
 M-F>8 (OT required for any hour greater than 8 worked each day, Mon through Fri.)
 OSA (Overtime (OT) is required for every hour worked on Saturday)
 OSH (Overtime is required for every hour worked on Sunday and Holidays)
 H/W (Health & Welfare Insurance)
 Pensn (Pension)
 Vac (Vacation)
 Trng (Training)

Explanations

DEKALB COUNTY

IRONWORKERS (NORTHWEST) - That portion of the county from a point where the western county line intersects with Rt. 30, continuing eastward to Shabbona, north between Shabbona and Clare, and northeast between Clare and New Lebanon.

The following list is considered as those days for which holiday rates of wages for work performed apply: New Years Day, Memorial Day, Fourth of July, Labor Day, Thanksgiving Day, Christmas Day and Veterans Day in some classifications/counties. Generally, any of these holidays which fall on a Sunday is celebrated on the following Monday. This then makes work performed on that Monday payable at the appropriate overtime rate for holiday pay. Common practice in a given local may alter certain days of celebration. If in doubt, please check with IDOL.

EXPLANATION OF CLASSES

ASBESTOS - GENERAL - removal of asbestos material/mold and hazardous materials from any place in a building, including mechanical systems where those mechanical systems are to be removed. This includes the removal of asbestos materials/mold and hazardous materials from ductwork or pipes in a building when the building is to be demolished at the time or at some close future date.

ASBESTOS - MECHANICAL - removal of asbestos material from mechanical systems, such as pipes, ducts, and boilers, where the mechanical systems are to remain.

CERAMIC TILE FINISHER

The grouting, cleaning, and polishing of all classes of tile, whether for interior or exterior purposes, all burned, glazed or unglazed products; all composition materials, granite tiles, warning detectable tiles, cement tiles, epoxy composite materials, pavers, glass, mosaics, fibreglass, and all substitute materials, for tile made in tile-like units; all mixtures in tile like form of cement, metals, and other materials that are for and intended for use as a finished floor surface, stair treads, promenade roofs, walks, walls, ceilings, swimming pools, and all other places where tile is to form a finished interior or exterior. The mixing of all setting mortars including but not limited to thin-set mortars, epoxies, wall mud, and any other sand and cement mixtures or adhesives when used in the preparation, installation, repair, or maintenance of tile and/or similar materials. The handling and unloading of all sand, cement, lime, tile, fixtures, equipment, adhesives, or any other materials to be used in the preparation, installation, repair, or maintenance of tile and/or similar materials. Ceramic Tile Finishers shall fill all joints and voids regardless of method on all tile work, particularly and especially after installation of said tile work. Application of any and all protective coverings to all types of tile installations including, but not be limited to, all soap compounds, paper products, tapes, and all polyethylene coverings, plywood, masonite, cardboard, and any new type of products that may be used to protect tile installations, Blastrac equipment, and all floor scarifying equipment used in preparing floors to receive tile. The clean up and removal of all waste and materials. All demolition of existing tile floors and walls to be re-tiled.

COMMUNICATIONS TECHNICIAN

Installing, manufacturing, assembling and maintaining sound and intercom, protection alarm (security), fire alarm, master antenna television, closed circuit television, low voltage control for computers and/or door monitoring, school communications systems, telephones and servicing of nurse and emergency calls, and the installation and maintenance of transmit and receive antennas, transmitters, receivers, and associated apparatus which operates in conjunction with above systems. All work associated with these system installations will be included EXCEPT the installation of protective

metallic conduit in new construction projects (excluding less than ten-foot, runs strictly for protection of cable) and 120 volt AC (or higher) power wiring and associated hardware.

LABORER, SKILLED - HIGHWAY

Individuals engaged in the following types of work, irrespective of the site of the work: asbestos abatement worker, handling of any materials with any foreign matter harmful to skin or clothing, track laborer, cement handlers, chloride handlers, the unloading and loading with steel workers and re-bars, concrete workers wet, tunnel helpers in free air, batch dumpers, mason tenders, kettle and tar men, tank cleaners, plastic installers, scaffold workers, motorized buggies or motorized unit used for wet concrete or handling of building materials, laborers with de-watering systems, sewer workers plus depth, rod and chainmen with technical engineers, rod and chainmen with land surveyors, rod and chainmen with surveyors, vibrator operators, cement silica, clay, fly ash, lime and plasters, handlers (bulk or bag), cofferdam workers plus depth, on concrete paving, placing, cutting and tying of reinforcing, deck hand, dredge hand, and shore laborers, bankmen on floating plant, grade checker, power tools, front end man on chip spreaders, cession workers plus depth, gunnite nozzle men, lead man on sewer work, welders, cutters, burners and torchmen, chainsaw operators, jackhammer and drill operators, layout man and/or drainage tile layer, steel form setter - street and highway, air tamping hammermen, signal man on crane, concrete saw operator, screedman on asphalt pavers, laborers tending masons with hot material or where foreign materials are used, mortar mixer operators, multiple concrete duct - leadsman, lumen, asphalt raker, curb asphalt machine operator, ready mix scalemen (permanent, portable or temporary plant), laborers handling masterplate or similar materials, laser beam operator, concrete burning machine operator, coring machine operator, plaster tender, underpinning and shoring of buildings, pump men, manhole and catch basin, dirt and stone tamper, hose men on concrete pumps, hazardous waste worker, lead base paint abatement worker, lining of pipe, refusing machine, assisting on direct boring machine, the work of laying watermain, fire hydrants, all mechanical joints to watermain work, sewer worker, and tapping water service and forced lift station mechanical worker.

MATERIAL TESTER I: Hand coring and drilling for testing of materials; field inspection of uncured concrete and asphalt.

MATERIAL TESTER II: Field inspection of welds, structural steel, fireproofing, masonry, soil, facade, reinforcing steel, formwork, cured concrete, and concrete and asphalt batch plants; adjusting proportions of bituminous mixtures.

OPERATING ENGINEERS - BUILDING

Class 1. Asphalt Plant; Asphalt Spreader; Autograde; Backhoes with Caisson Attachment; Batch Plant; Benoto (requires Two Engineers); Boiler and Throttle Valve; Caisson Rigs; Central Redi-Mix Plant; Combination Back Hoe Front End-loader Machine; Compressor and Throttle Valve; Concrete Breaker (Truck Mounted); Concrete Conveyor; Concrete Paver (over 27E cu. ft.); Concrete Paver (27 cu. ft. and under); Concrete Placer; Concrete Pump (Truck Mounted); Concrete Conveyor (Truck Mounted); Concrete Tower; Cranes, All; GCI and similar types (required two operators only); Cranes, Hammerhead; Creter Crane; Crusher, Stone, etc.; Derricks, All; Derricks, Traveling; Formless Curb and Gutter Machine; Grader, Elevating; Grouting Machines; Highlift Shovels or Front Endloader 2-1/4 yd. and over; Hoists, Elevators, outside type rack and pinion and similar machines; Hoists, one, two and three Drum; Hoists, Two Tugger One Floor; Hydraulic Backhoes; Hydraulic Boom Trucks; Hydro Vac (and similar equipment - excluding hose work and any sewer work); Locomotives, All; Lubrication Technician; Manipulators; Motor Patrol; Pile Drivers and Skid Rig; Post Hole Digger; Pre-Stress Machine; Pump Cretes Dual Ram; Pump Cretes: Squeeze Cretes - Screw Type Pumps, Gypsum Bulker and Pump; Raised and Blind Hole Drill; Rock Drill (self-propelled); Rock Drill - Truck Mounted; Roto Mill Grinder; Scoops - Tractor Drawn; Slipform Paver; Scrapers Prime Movers; Straddle Buggies; Tie Back Machine; Tractor with Boom and Side Boom; Trenching Machines.

Class 2. Bobcat (over 3/4 cu. yd.); Boilers; Brick Forklift; Broom, All Power Propelled; Bulldozers; Concrete Mixer (Two Bag and Over); Conveyor, Portable; Forklift Trucks; Highlift Shovels or Front Endloaders under 2-1/4 yd.; Hoists, Automatic; Hoists, Sewer Dragging Machine; Hoists, Tugger Single Drum; Laser Screed; Rollers, All; Steam Generators; Tractors, All; Tractor Drawn Vibratory Roller; Winch Trucks with "A" Frame.

Class 3. Air Compressor; Asphalt Spreader; Combination - Small Equipment Operator; Generators; Heaters, Mechanical; Hoists, Inside Elevators - (Rheostat Manual Controlled); Hydraulic Power Units (Pile Driving, Extracting, or Drilling - with a seat); Lowboys; Pumps, Over 3" (1 to 3 not to exceed total of 300 ft.); Pumps, Well Pumps; Welding Machines (2 through 5); Winches, 4 Small Electric Drill

Winches; Bobcat (up to and including 3/4 cu. yd.).

Class 4. Elevator push button with automatic doors; Hoists, Inside; Oilers; Brick Forklift.

Class 5. Assistant Craft Foreman

Class 6. Mechanics; Welders.

Class 7. Gradall

OPERATING ENGINEERS - HIGHWAY CONSTRUCTION

Class 1. Asphalt Plant; Asphalt Heater and Planer Combination; Asphalt Heater Scarfire; Asphalt Silo Tender; Asphalt Spreader; Autograder; ABG Paver; Backhoes with Caisson Attachment; Ballast Regulator; Belt Loader; Caisson Rigs; Car Dumper; Central Redi-Mix Plant; Backhoe w/shear attachments; Combination Backhoe Front Endloader Machine, (1 cu. yd. Backhoe Bucket or over or with attachments); Concrete Breaker (Truck Mounted); Concrete Conveyor; Concrete Paver over 27E cu. ft.; Concrete Placer; Concrete Tube Float; Cranes, all attachments; Cranes, Tower of all types; Creter Crane; Crusher, Stone, etc.; Derricks, All; Derrick Boats; Derricks, Traveling; Directional Boring Machine over 12"; Dredges; Formless Curb and Gutter Machine; Grader, Elevating; Grader, Motor Grader, Motor Patrol, Auto Patrol, Form Grader, Pull Grader, Subgrader; Guard Rail Post Driver Mounted; Hoists, One, Two and Three Drum; Hydraulic Backhoes; Hydro Vac, Self Propelled, Truck Mounted (excluding hose work and any sewer work); Lubrication Technician; Manipulators; Pile Drivers and Skid Rig; Pre-Stress Machine; Pump Cretes Dual Ram; Rock Drill - Crawler or Skid Rig; Rock Drill - Truck Mounted; Rock/Track Tamper; Roto Mill Grinder; Slip-Form Paver; Snow Melters; Soil Test Drill Rig (Truck Mounted); Straddle Buggies; GCI Crane; Hydraulic Telescoping Form (Tunnel); Tie Back Machine; Tractor Drawn Belt Loader; Tractor Drawn Belt Loader with attached pusher; Tractor with Boom; Tractaire with Attachments; Traffic Barrier Conveyor Machine; Raised or Blind Hole Drills; Trenching Machine (over 12"); Truck Mounted Concrete Pump with Boom; Truck Mounted Concrete Conveyor; Work Boat (no license required - 90 h.p. or above); Underground Boring and/or Mining Machines; Wheel Excavator; Widener (APSCO).

Class 2. Batch Plant; Bituminous Mixer; Boiler and Throttle Valve; Bulldozers; Car Loader Trailing Conveyors; Combination Backhoe Front Endloader Machine (less than 1 cu. yd. Backhoe Bucket or over or with attachments); Compressor and Throttle Valve; Compressor, Common Receiver (3); Concrete Breaker or Hydro Hammer; Concrete Grinding Machine; Concrete Mixer or Paver 7S Series to and including 27 cu. ft.; Concrete Spreader; Concrete Curing Machine, Burlap Machine, Belting Machine and Sealing Machine; Concrete Wheel Saw (large self-propelled - excluding walk-behinds and hand-held); Conveyor Muck Cars (Haglund or Similar Type); Drills, all; Finishing Machine - Concrete; Highlift Shovels or Front Endloader; Hoist - Sewer Dragging Machine; Hydraulic Boom Trucks (All Attachments); Hydro Blaster; All Locomotives, Dinky; Off-Road Hauling Units; Non-Self Loading Dump; Ejection Dump; Pump Cretes: Squeeze Cretes - Screw Type Pumps, Gypsum Bulker and Pump; Roller, Asphalt; Rotary Snow Plows; Rototiller, Seaman, etc., self-propelled; Scoops - Tractor Drawn; Self-Propelled Compactor; Spreader - Chip - Stone, etc.; Scraper; Scraper - Prime Mover in Tandem (Regardless of Size); Tank Car Heater; Tractors, Push, Pulling Sheeps Foot, Disc, Compactor, etc.; Tug Boats.

Class 3. Boilers; Brooms, All Power Propelled; Cement Supply Tender; Compressor, Common Receiver (2); Concrete Mixer (Two Bag and Over); Conveyor, Portable; Farm-Type Tractors Used for Mowing, Seeding, etc.; Fireman on Boilers; Forklift Trucks; Grouting Machine; Hoists, Automatic; Hoists, All Elevators; Hoists, Tugger Single Drum; Jeep Diggers; Low Boys; Pipe Jacking Machines; Post-Hole Digger; Power Saw, Concrete Power Driven; Pug Mills; Rollers, other than asphalt; Seed and Straw Blower; Steam Generators; Stump Machine; Winch Trucks with "A" Frame; Work Boats; Tamper - Form - Motor Driven.

Class 4. Air Compressor - Small and Large; Asphalt Spreader, Backend Man; Bobcat (Skid Steer) all; Brick Forklift; Combination - Small Equipment Operator; Directional Boring Machine up to 12"; Generators; Heaters, Mechanical; Hydraulic Power Unit (Pile Driving, Extracting, or Drilling); Hydro-Blaster; Light Plants, All (1 through 5); Pumps, over 3" (1 to 3 not to exceed a total of 300 ft.); Pumps, Well Points; Tractaire; Trencher 12" and under; Welding Machines (2 through 5); Winches, 4 Small Electric Drill Winches.

Class 5. Oilers and Directional Boring Machine Locator.

Class 6. Field Mechanics and Field Welders

Class 7. Gradall and machines of like nature.

SURVEY WORKER - Operated survey equipment including data collectors,

G.P.S. and robotic instruments, as well as conventional levels and transits.

TERRAZZO FINISHER

The handling of sand, cement, marble chips, and all other materials that may be used by the Mosaic Terrazzo Mechanic, and the mixing, grinding, grouting, cleaning and sealing of all Marble, Mosaic, and Terrazzo work, floors, base, stairs, and wainscoting by hand or machine, and in addition, assisting and aiding Marble, Masonic, and Terrazzo Mechanics.

TRUCK DRIVER - BUILDING, HEAVY AND HIGHWAY CONSTRUCTION

Class 1. Two or three Axle Trucks. A-frame Truck when used for transportation purposes; Air Compressors and Welding Machines, including those pulled by cars, pick-up trucks and tractors; Ambulances; Batch Gate Lockers; Batch Hopperman; Car and Truck Washers; Carry-alls; Fork Lifts and Hoisters; Helpers; Mechanics Helpers and Greasers; Oil Distributors 2-man operation; Pavement Breakers; Pole Trailer, up to 40 feet; Power Mower Tractors; Self-propelled Chip Spreader; Skipman; Slurry Trucks, 2-man operation; Slurry Truck Conveyor Operation, 2 or 3 man; Teamsters Unskilled dumpman; and Truck Drivers hauling warning lights, barricades, and portable toilets on the job site.

Class 2. Four axle trucks; Dump Crets and Adgetors under 7 yards; Dumpsters, Track Trucks, Euclids, Hug Bottom Dump Turnapulls or Turntrailers when pulling other than self-loading equipment or similar equipment under 16 cubic yards; Mixer Trucks under 7 yards; Ready-mix Plant Hopper Operator, and Winch Trucks, 2 Axles.

Class 3. Five axle trucks; Dump Crets and Adgetors 7 yards and over; Dumpsters, Track Trucks, Euclids, Hug Bottom Dump Turntrailers or turnapulls when pulling other than self-loading equipment or similar equipment over 16 cubic yards; Explosives and/or Fission Material Trucks; Mixer Trucks 7 yards or over; Mobile Cranes while in transit; Oil Distributors, 1-man operation; Pole Trailer, over 40 feet; Pole and Expandable Trailers hauling material over 50 feet long; Slurry trucks, 1-man operation; Winch trucks, 3 axles or more; Mechanic--Truck Welder and Truck Painter.

Class 4. Six axle trucks; Dual-purpose vehicles, such as mounted crane trucks with hoist and accessories; Foreman; Master Mechanic; Self-loading equipment like P.B. and trucks with scoops on the front.

Other Classifications of Work:

For definitions of classifications not otherwise set out, the Department generally has on file such definitions which are available. If a task to be performed is not subject to one of the classifications of pay set out, the Department will upon being contacted state which neighboring county has such a classification and provide such rate, such rate being deemed to exist by reference in this document. If no neighboring county rate applies to the task, the Department shall undertake a special determination, such special determination being then deemed to have existed under this determination. If a project requires these, or any classification not listed, please contact IDOL at 217-782-1710 for wage rates or clarifications.

LANDSCAPING

Landscaping work falls under the existing classifications for laborer, operating engineer and truck driver. The work performed by landscape plantsman and landscape laborer is covered by the existing classification of laborer. The work performed by landscape operators (regardless of equipment used or its size) is covered by the classifications of operating engineer. The work performed by landscape truck drivers (regardless of size of truck driven) is covered by the classifications of truck driver.

BDE SPECIAL PROVISIONS
For the April 24 and June 12, 2015 Lettings

The following special provisions indicated by an "x" are applicable to this contract and will be included by the Project Development and Implementation Section of the BD&E. An * indicates a new or revised special provision for the letting.

<u>File Name</u>	<u>#</u>		<u>Special Provision Title</u>	<u>Effective</u>	<u>Revised</u>
80240	1	<input type="checkbox"/>	Above Grade Inlet Protection	July 1, 2009	Jan. 1, 2012
80099	2	<input type="checkbox"/>	Accessible Pedestrian Signals (APS)	April 1, 2003	Jan. 1, 2014
80274	3	<input type="checkbox"/>	Aggregate Subgrade Improvement	April 1, 2012	Jan. 1, 2013
80192	4	<input type="checkbox"/>	Automated Flagger Assistance Device	Jan. 1, 2008	
80173	5	<input type="checkbox"/>	Bituminous Materials Cost Adjustments	Nov. 2, 2006	Aug. 1, 2013
80241	6	<input type="checkbox"/>	Bridge Demolition Debris	July 1, 2009	
5026I	7	<input type="checkbox"/>	Building Removal-Case I (Non-Friable and Friable Asbestos)	Sept. 1, 1990	April 1, 2010
5048I	8	<input type="checkbox"/>	Building Removal-Case II (Non-Friable Asbestos)	Sept. 1, 1990	April 1, 2010
5049I	9	<input type="checkbox"/>	Building Removal-Case III (Friable Asbestos)	Sept. 1, 1990	April 1, 2010
5053I	10	<input type="checkbox"/>	Building Removal-Case IV (No Asbestos)	Sept. 1, 1990	April 1, 2010
80310	11	<input type="checkbox"/>	Coated Galvanized Steel Conduit	Jan. 1, 2013	Jan. 1, 2015
80341	12	<input type="checkbox"/>	Coilable Nonmetallic Conduit	Aug. 1, 2014	Jan. 1, 2015
80198	13	<input type="checkbox"/>	Completion Date (via calendar days)	April 1, 2008	
80199	14	<input type="checkbox"/>	Completion Date (via calendar days) Plus Working Days	April 1, 2008	
*	80293	15	Concrete Box Culverts with Skews > 30 Degrees and Design Fills ≤ 5 Feet	April 1, 2012	April 1, 2015
	80294	16	Concrete Box Culverts with Skews ≤ 30 Degrees Regardless of Design Fill and Skews > 30 Degrees with Design Fills > 5 Feet	April 1, 2012	April 1, 2014
	80311	17	Concrete End Sections for Pipe Culverts	Jan. 1, 2013	
	80334	18	Concrete Gutter, Curb, Median, and Paved Ditch	April 1, 2014	Aug. 1, 2014
	80277	19	Concrete Mix Design – Department Provided	Jan. 1, 2012	Jan. 1, 2014
	80261	20	Construction Air Quality – Diesel Retrofit	June 1, 2010	Nov. 1, 2014
	80335	21	Contract Claims	April 1, 2014	
*	80029	22	Disadvantaged Business Enterprise Participation	Sept. 1, 2000	Jan. 2, 2015
*	80358	23	Equal Employment Opportunity	April 1, 2015	
	80265	24	<input checked="" type="checkbox"/> Friction Aggregate	Jan. 1, 2011	Nov. 1, 2014
	80229	25	<input type="checkbox"/> Fuel Cost Adjustment	April 1, 2009	July 1, 2009
	80329	26	<input type="checkbox"/> Glare Screen	Jan. 1, 2014	
	80304	27	<input type="checkbox"/> Grooving for Recessed Pavement Markings	Nov. 1, 2012	Aug. 1, 2014
	80246	28	<input checked="" type="checkbox"/> Hot-Mix Asphalt – Density Testing of Longitudinal Joints	Jan. 1, 2010	April 1, 2012
	80322	29	<input checked="" type="checkbox"/> Hot-Mix Asphalt – Mixture Design Composition and Volumetric Requirements	Nov. 1, 2013	Nov. 1, 2014
	80323	30	<input checked="" type="checkbox"/> Hot-Mix Asphalt – Mixture Design Verification and Production	Nov. 1, 2013	Nov. 1, 2014
*	80347	31	Hot-Mix Asphalt – Pay for Performance Using Percent Within Limits – Jobsite Sampling	Nov. 1, 2014	April 1, 2015
	80348	32	<input checked="" type="checkbox"/> Hot-Mix Asphalt – Prime Coat	Nov. 1, 2014	
	80315	33	<input type="checkbox"/> Insertion Lining of Culverts	Jan. 1, 2013	Nov. 1, 2013
	80351	34	<input type="checkbox"/> Light Tower	Jan. 1, 2015	
	80336	35	<input type="checkbox"/> Longitudinal Joint and Crack Patching	April 1, 2014	
*	80324	36	LRFD Pipe Culvert Burial Tables	Nov. 1, 2013	April 1, 2015
*	80325	37	LRFD Storm Sewer Burial Tables	Nov. 1, 2013	April 1, 2015
	80045	38	<input type="checkbox"/> Material Transfer Device	June 15, 1999	Aug. 1, 2014
	80342	39	<input type="checkbox"/> Mechanical Side Tie Bar Inserter	Aug. 1, 2014	Jan. 1, 2015
	80165	40	<input type="checkbox"/> Moisture Cured Urethane Paint System	Nov. 1, 2006	Jan. 1, 2010
	80337	41	<input type="checkbox"/> Paved Shoulder Removal	April 1, 2014	
	80349	42	<input type="checkbox"/> Pavement Marking Blackout Tape	Nov. 1, 2014	
	80298	43	<input type="checkbox"/> Pavement Marking Tape Type IV	April 1, 2012	

<u>File Name</u>	<u>#</u>	<u>Special Provision Title</u>	<u>Effective</u>	<u>Revised</u>
80254	44	Pavement Patching	Jan. 1, 2010	
80352	45	Pavement Striping - Symbols	Jan. 1, 2015	
* 80359	46	Portland Cement Concrete Bridge Deck Curing	April 1, 2015	
* 80353	47	Portland Cement Concrete Inlay or Overlay	Jan. 1, 2015	April 1, 2015
80338	48	Portland Cement Concrete Partial Depth Hot-Mix Asphalt Patching	April 1, 2014	
80343	49	Precast Concrete Handhole	Aug. 1, 2014	
80300	50	Preformed Plastic Pavement Marking Type D - Inlaid	April 1, 2012	
80328	51	Progress Payments	Nov. 2, 2013	
3426I	52	Railroad Protective Liability Insurance	Dec. 1, 1986	Jan. 1, 2006
80157	53	Railroad Protective Liability Insurance (5 and 10)	Jan. 1, 2006	
80306	54	✓ Reclaimed Asphalt Pavement (RAP) and Reclaimed Asphalt Shingles (RAS)	Nov. 1, 2012	April 1, 2014
80350	55	Retroreflective Sheeting for Highway Signs	Nov. 1, 2014	
80327	56	Reinforcement Bars	Nov. 1, 2013	
80344	57	Rigid Metal Conduit	Aug. 1, 2014	
* 80354	58	Sidewalk, Corner, or Crosswalk Closure	Jan. 1, 2015	April 1, 2015
80340	59	Speed Display Trailer	April 2, 2014	
80127	60	Steel Cost Adjustment	April 2, 2004	April 1, 2009
80317	61	Surface Testing of Hot-Mix Asphalt Overlays	Jan. 1, 2013	
80355	62	Temporary Concrete Barrier	Jan. 1, 2015	
80301	63	Tracking the Use of Pesticides	Aug. 1, 2012	
80356	64	Traffic Barrier Terminals Type 6 or 6B	Jan. 1, 2015	
20338	65	Training Special Provisions	Oct. 15, 1975	
80318	66	Traversable Pipe Grate	Jan. 1, 2013	April 1, 2014
* 80345	67	Underpass Luminaire	Aug. 1, 2014	April 1, 2015
80357	68	Urban Half Road Closure with Mountable Median	Jan. 1, 2015	
* 80346	69	Waterway Obstruction Warning Luminaire	Aug. 1, 2014	April 1, 2015
80288	70	Warm Mix Asphalt	Jan. 1, 2012	Nov. 1, 2014
80302	71	Weekly DBE Trucking Reports	June 2, 2012	
80289	72	Wet Reflective Thermoplastic Pavement Marking	Jan. 1, 2012	
80071	73	Working Days	Jan. 1, 2002	

The following special provisions are in the 2015 Supplemental Specifications and Recurring Special Provisions:

<u>File Name</u>	<u>Special Provision Title</u>	<u>New Location</u>	<u>Effective</u>	<u>Revised</u>
80292	Coarse Aggregate in Bridge Approach Slabs/Footings	Articles 1004.01(b) and 1004.02(f)	April 1, 2012	April 1, 2013
80303	Granular Materials	Articles 1003.04, 1003.04(c), and 1004.05(c)	Nov. 1, 2012	
80330	Pavement Marking for Bike Symbol	Article 780.14	Jan. 1, 2014	
80331	Payrolls and Payroll Records	Recurring CS #1 and #5	Jan. 1, 2014	
80332	Portland Cement Concrete – Curing of Abutments and Piers	Article 1020.13	Jan. 1, 2014	
80326	Portland Cement Concrete Equipment	Article 1103.03(a)(5)	Nov. 1, 2013	
80281	Quality Control/Quality Assurance of Concrete Mixtures	Recurring CS #31	Jan. 1, 2012	Jan. 1, 2014
80283	Removal and Disposal of Regulated Substances	Articles 669.01, 669.08, 669.09, 669.14, and 669.16	Jan. 1, 2012	Nov. 2, 2012
80319	Removal and Disposal of Surplus Materials	Article 202.03	Nov. 2, 2012	
80307	Seeding	Article 250.07	Nov. 1, 2012	
80339	Stabilized Subbase	Article 312.06	April 1, 2014	
80333	Traffic Control Setup and Removal Freeway/Expressway	Articles 701.18(l) and 701.19(a)	Jan. 1, 2014	

The following special provisions require additional information from the designer. The additional information needs to be included in a separate document attached to this check sheet. The Project Development and Implementation section will then include the information in the applicable special provision. The Special Provisions are:

- Bridge Demolition Debris
- Building Removal-Case I
- Building Removal-Case II
- Building Removal-Case III
- Building Removal-Case IV
- Completion Date
- Completion Date Plus Working Days
- DBE Participation
- Material Transfer Device
- Railroad Protective Liability Insurance
- Training Special Provisions
- Working Days

FRICITION AGGREGATE (BDE)

Effective: January 1, 2011

Revised: November 1, 2014

Revise Article 1004.01(a)(4) of the Standard Specifications to read:

“(4) Crushed Stone. Crushed stone shall be the angular fragments resulting from crushing undisturbed, consolidated deposits of rock by mechanical means. Crushed stone shall be divided into the following, when specified.

- a. Carbonate Crushed Stone. Carbonate crushed stone shall be either dolomite or limestone. Dolomite shall contain 11.0 percent or more magnesium oxide (MgO). Limestone shall contain less than 11.0 percent magnesium oxide (MgO).
- b. Crystalline Crushed Stone. Crystalline crushed stone shall be either metamorphic or igneous stone, including but is not limited to, quartzite, granite, rhyolite and diabase.”

Revise Article 1004.03(a) of the Standard Specifications to read:

“**1004.03 Coarse Aggregate for Hot-Mix Asphalt (HMA).** The aggregate shall be according to Article 1004.01 and the following.

(a) Description. The coarse aggregate for HMA shall be according to the following table.

Use	Mixture	Aggregates Allowed
Class A	Seal or Cover	<u>Allowed Alone or in Combination</u> ^{5/} : Gravel Crushed Gravel Carbonate Crushed Stone Crystalline Crushed Stone Crushed Sandstone Crushed Slag (ACBF) Crushed Steel Slag Crushed Concrete

Use	Mixture	Aggregates Allowed		
HMA Low ESAL	Stabilized Subbase or Shoulders	<u>Allowed Alone or in Combination</u> ^{5/} : Gravel Crushed Gravel Carbonate Crushed Stone Crystalline Crushed Stone Crushed Sandstone Crushed Slag (ACBF) Crushed Steel Slag ^{1/} Crushed Concrete		
HMA High ESAL Low ESAL	Binder IL-19.0 or IL-19.0L SMA Binder	<u>Allowed Alone or in Combination</u> ^{5/} : Crushed Gravel Carbonate Crushed Stone ^{2/} Crystalline Crushed Stone Crushed Sandstone Crushed Slag (ACBF) Crushed Concrete ^{3/}		
HMA High ESAL Low ESAL	C Surface and Leveling Binder IL-9.5 or IL-9.5L SMA Ndesign 50 Surface	<u>Allowed Alone or in Combination</u> ^{5/} : Crushed Gravel Carbonate Crushed Stone ^{2/} Crystalline Crushed Stone Crushed Sandstone Crushed Slag (ACBF) Crushed Steel Slag ^{4/} Crushed Concrete ^{3/}		
HMA High ESAL	D Surface and Leveling Binder IL-9.5 SMA Ndesign 50 Surface	<u>Allowed Alone or in Combination</u> ^{5/} : Crushed Gravel Carbonate Crushed Stone (other than Limestone) ^{2/} Crystalline Crushed Stone Crushed Sandstone Crushed Slag (ACBF) Crushed Steel Slag ^{4/} Crushed Concrete ^{3/}		
		<u>Other Combinations Allowed:</u>		
		<table border="1"> <tr> <td><i>Up to...</i></td> <td><i>With...</i></td> </tr> <tr> <td>25% Limestone</td> <td>Dolomite</td> </tr> </table>	<i>Up to...</i>	<i>With...</i>
<i>Up to...</i>	<i>With...</i>			
25% Limestone	Dolomite			

Use	Mixture	Aggregates Allowed	
		50% Limestone	Any Mixture D aggregate other than Dolomite
		75% Limestone	Crushed Slag (ACBF) or Crushed Sandstone
HMA High ESAL	E Surface IL-9.5 SMA Ndesign 80 Surface	<u>Allowed Alone or in Combination</u> ^{5/} : Crushed Gravel Crystalline Crushed Stone Crushed Sandstone Crushed Slag (ACBF) Crushed Steel Slag Crushed Concrete ^{3/} No Limestone.	
		<u>Other Combinations Allowed:</u>	
		<i>Up to...</i>	<i>With...</i>
		50% Dolomite ^{2/}	Any Mixture E aggregate
		75% Dolomite ^{2/}	Crushed Sandstone, Crushed Slag (ACBF), Crushed Steel Slag, or Crystalline Crushed Stone
		75% Crushed Gravel or Crushed Concrete ^{3/}	Crushed Sandstone, Crystalline Crushed Stone, Crushed Slag (ACBF), or Crushed Steel Slag
HMA High ESAL	F Surface IL-9.5 SMA Ndesign 80 Surface	<u>Allowed Alone or in Combination</u> ^{5/} : Crystalline Crushed Stone Crushed Sandstone Crushed Slag (ACBF) Crushed Steel Slag No Limestone.	
		<u>Other Combinations Allowed:</u>	

Use	Mixture	Aggregates Allowed	
		<i>Up to...</i>	<i>With...</i>
		50% Crushed Gravel, Crushed Concrete ^{3/} , or Dolomite ^{2/}	Crushed Sandstone, Crushed Slag (ACBF), Crushed Steel Slag, or Crystalline Crushed Stone

- 1/ Crushed steel slag allowed in shoulder surface only.
- 2/ Carbonate crushed stone shall not be used in SMA Ndesign 80. In SMA Ndesign 50, carbonate crushed stone shall not be blended with any of the other aggregates allowed alone in Ndesign 50 SMA binder or Ndesign 50 SMA surface.
- 3/ Crushed concrete will not be permitted in SMA mixes.
- 4/ Crushed steel slag shall not be used as leveling binder.
- 5/ When combinations of aggregates are used, the blend percent measurements shall be by volume.”

HOT-MIX ASPHALT - DENSITY TESTING OF LONGITUDINAL JOINTS (BDE)

Effective: January 1, 2010

Revised: April 1, 2012

Description. This work shall consist of testing the density of longitudinal joints as part of the quality control/quality assurance (QC/QA) of hot-mix asphalt (HMA). Work shall be according to Section 1030 of the Standard Specifications except as follows.

Quality Control/Quality Assurance (QC/QA). Delete the second and third sentence of the third paragraph of Article 1030.05(d)(3) of the Standard Specifications.

Add the following paragraphs to the end of Article 1030.05(d)(3) of the Standard Specifications:

“Longitudinal joint density testing shall be performed at each random density test location. Longitudinal joint testing shall be located at a distance equal to the lift thickness or a minimum of 4 in. (100 mm), from each pavement edge. (i.e. for a 5 in. (125 mm) lift the near edge of the density gauge or core barrel shall be within 5 in. (125 mm) from the edge of pavement.) Longitudinal joint density testing shall be performed using either a correlated nuclear gauge or cores.

- a. Confined Edge. Each confined edge density shall be represented by a one-minute nuclear density reading or a core density and shall be included in the average of density readings or core densities taken across the mat which represents the Individual Test.
- b. Unconfined Edge. Each unconfined edge joint density shall be represented by an average of three one-minute density readings or a single core density at the given density test location and shall meet the density requirements specified herein. The three one-minute readings shall be spaced ten feet apart longitudinally along the unconfined pavement edge and centered at the random density test location.”

Revise the Density Control Limits table in Article 1030.05(d)(4) of the Standard Specifications to read:

“Mixture Composition	Parameter	Individual Test (includes confined edges)	Unconfined Edge Joint Density Minimum
IL-4.75	Ndesign = 50	93.0 – 97.4%	91.0%
IL-9.5, IL-12.5	Ndesign ≥ 90	92.0 – 96.0%	90.0%
IL-9.5, IL-9.5L, IL-12.5	Ndesign < 90	92.5 – 97.4%	90.0%
IL-19.0, IL-25.0	Ndesign ≥ 90	93.0 – 96.0%	90.0%
IL-19.0, IL-19.0L, IL-25.0	Ndesign < 90	93.0 – 97.4%	90.0%

SMA	Ndesign = 50 & 80	93.5 – 97.4%	91.0%
All Other	Ndesign = 30	93.0 - 97.4%	90.0%”

80246

HOT-MIX ASPHALT – MIXTURE DESIGN COMPOSITION AND VOLUMETRIC REQUIREMENTS (BDE)

Effective: November 1, 2013

Revised: November 1, 2014

Revise the last sentence of the first paragraph of Article 312.05 of the Standard Specifications to read:

“The minimum compacted thickness of each lift shall be according to Article 406.06(d).”

Delete the minimum compacted lift thickness table in Article 312.05 of the Standard Specifications.

Revise the second paragraph of Article 355.02 of the Standard Specifications to read:

“The mixture composition used shall be IL-19.0.”

Revise Article 355.05(a) of the Standard Specifications to read:

“(a) The top lift thickness shall be 2 1/4 in. (60 mm) for mixture composition IL-19.0.”

Revise the Leveling Binder table and second paragraph of Article 406.05(c) of the Standard Specifications to read:

“Leveling Binder	
Nominal, Compacted, Leveling Binder Thickness, in. (mm)	Mixture Composition
≤ 1 1/4 (32)	IL-4.75, IL-9.5, or IL-9.5L
> 1 1/4 to 2 (32 to 50)	IL-9.5 or IL-9.5L

The density requirements of Article 406.07(c) shall apply for leveling binder, machine method, when the nominal compacted thickness is: 3/4 in. (19 mm) or greater for IL-4.75 mixtures; and 1 1/4 in. (32 mm) or greater for IL-9.5 and IL-9.5L mixtures.”

Revise the table in Article 406.06(d) of the Standard Specifications to read:

“MINIMUM COMPACTED LIFT THICKNESS	
Mixture Composition	Thickness, in. (mm)
IL-4.75	3/4 (19)
IL-9.5, IL-9.5L	1 1/4 (32)
SMA-12.5	1 1/2 (38)
IL-19.0, IL-19.0L	2 1/4 (57)”

Revise the ninth paragraph of Article 406.14 of the Standard Specifications to read:

“Test strip mixture will be evaluated at the contract unit price according to the following.”

Revise Article 406.14(a) of the Standard Specifications to read:

“(a) If the HMA placed during the initial test strip is determined to be acceptable the mixture will be paid for at the contract unit price.”

Revise Article 406.14(b) of the Standard Specifications to read:

“(b) If the HMA placed during the initial test strip (1) is determined to be unacceptable to remain in place by the Engineer, and (2) was not produced within 2.0 to 6.0 percent air voids or within the individual control limits of the JMF according to the Department’s test results, the mixture will not be paid for and shall be removed at the Contractor’s expense. An additional test strip shall be constructed and the mixture will be paid for in full, if produced within 2.0 to 6.0 percent air voids and within the individual control limits of the JMF.”

Revise Article 406.14(c) of the Standard Specifications to read:

“(c) If the HMA placed during the initial test strip (1) is determined to be unacceptable to remain in place by the Engineer, and (2) was produced within 2.0 to 6.0 percent air voids and within the individual control limits of the JMF according to the Department’s test results, the mixture shall be removed. Removal will be paid according to Article 109.04. This initial mixture will be paid for at the contract unit price. An additional test strip shall be constructed and the mixture will be paid for in full, if produced within 2.0 to 6.0 percent air voids and within the individual control limits of the JMF.”

Delete Article 406.14(d) of the Standard Specifications.

Delete Article 406.14(e) of the Standard Specifications.

Delete the last sentence of Article 407.06(c) of the Standard Specifications.

Revise Note 2. of Article 442.02 of the Standard Specifications to read:

“Note 2. The mixture composition of the HMA used shall be IL-19.0 binder, designed with the same Ndesign as that specified for the mainline pavement.”

Delete the second paragraph of Article 482.02 of the Standard Specifications.

Revise the first sentence of the sixth paragraph of Article 482.05 of the Standard Specifications to read:

“When the mainline HMA binder and surface course mixture option is used on resurfacing projects, shoulder resurfacing widths of 6 ft (1.8 m) or less may be placed simultaneously with the adjacent traffic lane for both the binder and surface courses.”

Revise the second sentence of the fourth paragraph of Article 601.04 of the Standard Specifications to read:

“The top 5 in. (125 mm) of the trench shall be backfilled with an IL-19.0L Low ESAL mixture meeting the requirements of Section 1030 and compacted to a density of not less than 90 percent of the theoretical density.”

Revise the second sentence of the fifth paragraph of Article 601.04 of the Standard Specifications to read:

“The top 8 in. (200 mm) of the trench shall be backfilled with an IL-19.0L Low ESAL mixture meeting the requirements of Section 1030 and compacted to a density of not less than 90 percent of the theoretical density.”

Revise Article 1003.03(c) of the Standard Specifications to read:

“(c) Gradation. The fine aggregate gradation for all HMA shall be FA 1, FA 2, FA 20, FA 21, or FA 22. The fine aggregate gradation for SMA shall be FA/FM 20.

For mixture IL-4.75 and surface mixtures with an $N_{design} = 90$, at least 50 percent of the required fine aggregate fraction shall consist of either stone sand, slag sand, or steel slag meeting the FA 20 gradation.

For mixture IL-19.0, $N_{design} = 90$ the fine aggregate fraction shall consist of at least 67 percent manufactured sand meeting FA 20 or FA 22 gradation. For mixture IL-19.0, $N_{design} = 50$ or 70 the fine aggregate fraction shall consist of at least 50 percent manufactured sand meeting FA 20 or FA 22 gradation. The manufactured sand shall be stone sand, slag sand, steel slag sand, or combinations thereof.

Gradation FA 1, FA 2, or FA 3 shall be used when required for prime coat aggregate application for HMA.”

Remove footnote 3/ from the tables and at the end of the tables in Article 1004.01(c) of the Standard Specifications.

Delete the last sentence of the first paragraph of Article 1004.03(b) of the Standard Specifications.

Revise the table in Article 1004.03(c) of the Standard Specifications to read:

“Use	Size/Application	Gradation No.
Class A-1, 2, & 3	3/8 in. (10 mm) Seal	CA 16
Class A-1	1/2 in. (13 mm) Seal	CA 15
Class A-2 & 3	Cover	CA 14
HMA High ESAL	IL-19.0 IL-9.5	CA 11 ^{1/} CA 16 and/or CA 13 CA 16
HMA Low ESAL	IL-19.0L IL-9.5L Stabilized Subbase or Shoulders	CA 11 ^{1/} CA 16

1/ CA 16 or CA 13 may be blended with the gradations listed.”

Revise the nomenclature table in Article 1030.01 of the Standard Specifications to read:

“High ESAL	IL-19.0 binder; IL-9.5 surface
Low ESAL	IL-19.0L binder; IL-9.5L surface; Stabilized Subbase (HMA) ^{1/} ; HMA Shoulders ^{2/}

1/ Uses 19.0L binder mix.

2/ Uses 19.0L for lower lifts and 9.5L for surface lift.”

Revise Article 1030.02 of the Standard Specifications and Supplemental Specifications to read:

“**1030.02 Materials.** Materials shall be according to the following.

Item	Article/Section
(a) Coarse Aggregate	1004.03
(b) Fine Aggregate	1003.03
(c) RAP Material	1031
(d) Mineral Filler	1011
(e) Hydrated Lime	1012.01
(f) Slaked Quicklime (Note 1)	
(g) Performance Graded Asphalt Binder (Note 2)	1032
(h) Fibers (Note 3)	
(i) Warm Mix Asphalt (WMA) Technologies (Note 4)	

Note 1. Slaked quicklime shall be according to ASTM C 5.

Note 2. The asphalt binder shall be an SBS PG 76-28 when the SMA is used on a full-depth asphalt pavement and SBS PG 76-22 when used as an overlay.

Note 3. A stabilizing additive such as cellulose or mineral fiber shall be added to the SMA mixture according to Illinois Modified AASHTO M 325. The stabilizing additive shall meet the Fiber Quality Requirements listed in Illinois Modified AASHTO M 325. Prior to approval and use of fibers, the Contractor shall submit a notarized certification by the producer of these materials stating they meet these requirements.

Note 4. Warm mix additives or foaming processes shall be selected from the current Bureau of Materials and Physical Research Approved List, "Warm Mix Asphalt Technologies".

Revise Article 1030.04(a)(1) of the Standard Specifications and the Supplemental Specifications to read:

“(1) High ESAL Mixtures. The Job Mix Formula (JMF) shall fall within the following limits.

High ESAL, MIXTURE COMPOSITION (% PASSING) ^{1/}								
Sieve Size	IL-19.0 mm		SMA 12.5 ^{4/}		IL-9.5 mm		IL-4.75 mm	
	min	max	min	max	min	max	min	max
1 1/2 in. (37.5 mm)								
1 in. (25 mm)		100						
3/4 in. (19 mm)	90	100		100				
1/2 in. (12.5 mm)	75	89	90	99		100		100
3/8 in. (9.5 mm)			50	85	90	100		100
#4 (4.75 mm)	40	60	20	40	32	69	90	100
#8 (2.36 mm)	26	42	16	24 ^{5/}	32	52 ^{2/}	70	90
#16 (1.18 mm)	15	30			10	32	50	65
#50 (300 μm)	6	15			4	15	15	30
#100 (150 μm)	4	9			3	10	10	18
#200 (75 μm)	3	6	8.0	11.0 ^{3/}	4	6	7	9
Ratio Dust/Asphalt Binder		1.0				1.0		1.0 ^{3/}

1/ Based on percent of total aggregate weight.

2/ The mixture composition shall not exceed 44 percent passing the #8 (2.36 mm) sieve for surface courses with Ndesign = 90.

3/ Additional minus No. 200 (0.075 mm) material required by the mix design shall be mineral filler, unless otherwise approved by the Engineer.

4/ The maximum percent passing the #635 (20 µm) sieve shall be ≤ 3 percent.

5/ When establishing the Adjusted Job Mix Formula (AJMF) the percent passing the #8 (2.36 mm) sieve shall not be adjusted above 24 percent.”

Delete Article 1030.04(a)(3) of the Standard Specifications.

Delete Article 1030.04(a)(4) of the Standard Specifications.

Revise the table in Article 1030.04(b)(1) of the Standard Specifications to read:

“VOLUMETRIC REQUIREMENTS High ESAL				
	Voids in the Mineral Aggregate (VMA), % minimum			Voids Filled with Asphalt Binder (VFA), %
N _{design}	IL-19.0	IL-9.5	IL-4.75 ^{1/}	
50	13.5	15.0	18.5	65 – 78 ^{2/}
70				
90				

1/ Maximum Draindown for IL-4.75 shall be 0.3 percent

2/ VFA for IL-4.75 shall be 76-83 percent”

Revise the table in Article 1030.04(b)(2) of the Standard Specifications to read:

“VOLUMETRIC REQUIREMENTS Low ESAL				
Mixture Composition	Design Compactive Effort	Design Air Voids Target %	VMA (Voids in the Mineral Aggregate), % min.	VFA (Voids Filled with Asphalt Binder), %
IL-9.5L	N _{DES} =30	4.0	15.0	65-78
IL-19.0L	N _{DES} =30	4.0	13.5	N/A”

Replace Article 1030.04(b)(3) of the Standard Specifications with the following:

“(3) SMA Mixtures.

ESALs (million)	Ndesign	Design Air Voids Target %	Voids in the Mineral Aggregate (VMA), % min.	Voids Filled with Asphalt (VFA), %
≤ 10	50	4.0	16.0	75 – 80
> 10	80	4.0	17.0	75 – 80”

Delete Article 1030.04(b)(4) of the Standard Specifications.

Delete Article 1030.04(b)(5) from the Supplemental Specifications.

Revise the table in Article 1030.05(d)(2)a. of the Standard Specifications to read:

“Parameter	Frequency of Tests		Test Method See Manual of Test Procedures for Materials
	High ESAL Mixture	Low ESAL Mixture	
Aggregate Gradation % passing sieves: 1/2 in. (12.5 mm), No. 4 (4.75 mm), No. 8 (2.36 mm), No. 30 (600 µm) No. 200 (75 µm)	1 washed ignition oven test on the mix per half day of production	Note 3.	Illinois Procedure
Asphalt Binder Content by Ignition Oven Note 1.	1 per half day of production		Illinois-Modified AASHTO T 308
VMA Note 2.	Day’s production ≥ 1200 tons: 1 per half day of production	Day’s production < 1200 tons: 1 per half day of production for first 2 days and 1 per day thereafter (first sample of the day)	Illinois-Modified AASHTO R 35

"Parameter	Frequency of Tests		Test Method See Manual of Test Procedures for Materials
	High ESAL Mixture	Low ESAL Mixture	
Air Voids Bulk Specific Gravity of Gyratory Sample Note 4.	Day's production ≥ 1200 tons: 1 per half day of production	Illinois-Modified AASHTO T 312	
	Day's production < 1200 tons: 1 per half day of production for first 2 days and 1 per day thereafter (first sample of the day)		
Maximum Specific Gravity of Mixture	Day's production ≥ 1200 tons: 1 per half day of production	Illinois-Modified AASHTO T 209	
	Day's production < 1200 tons: 1 per half day of production for first 2 days and 1 per day thereafter (first sample of the day)		

Note 1. The Engineer may waive the ignition oven requirement for asphalt binder content if the aggregates to be used are known to have ignition asphalt binder content calibration factors which exceed 1.5 percent. If the ignition oven requirement is waived, other Department approved methods shall be used to determine the asphalt binder content.

Note 2. The G_{sb} used in the voids in the mineral aggregate (VMA) calculation shall be the same average G_{sb} value listed in the mix design.

Note 3. The Engineer reserves the right to require additional hot bin gradations for batch plants if control problems are evident.

Note 4. The WMA compaction temperature for mixture volumetric testing shall be 270 ± 5 °F (132 ± 3 °C) for quality control testing. The WMA compaction temperature for quality assurance testing will be 270 ± 5 °F (132 ± 3 °C) if the mixture is not allowed to cool to room temperature. If the mixture is allowed to cool to room temperature, it shall be reheated to standard HMA compaction temperatures."

Revise the table in Article 1030.05(d)(2)b. of the Standard Specifications to read:

“Parameter	High ESAL Mixture Low ESAL Mixture
Ratio Dust/Asphalt Binder	0.6 to 1.2
Moisture	0.3 %”

Revise the Article 1030.05(d)(4) of the Supplemental Specifications to read:

“(4) Control Limits. Target values shall be determined by applying adjustment factors to the AJMF where applicable. The target values shall be plotted on the control charts within the following control limits.

CONTROL LIMITS						
Parameter	High ESAL Low ESAL		SMA		IL-4.75	
	Individual Test	Moving Avg. of 4	Individual Test	Moving Avg. of 4	Individual Test	Moving Avg. of 4
% Passing: ^{1/}						
1/2 in. (12.5 mm)	± 6 %	± 4 %	± 6 %	± 4 %		
3/8 in. (9.5mm)			± 4 %	± 3 %		
No. 4 (4.75 mm)	± 5 %	± 4 %	± 5 %	± 4 %		
No. 8 (2.36 mm)	± 5 %	± 3 %	± 4 %	± 2 %		
No. 16 (1.18 mm)			± 4 %	± 2 %	± 4 %	± 3 %
No. 30 (600 µm)	± 4 %	± 2.5 %	± 4 %	± 2.5 %		
Total Dust Content No. 200 (75 µm)	± 1.5 %	± 1.0 %			± 1.5 %	± 1.0 %
Asphalt Binder Content	± 0.3 %	± 0.2 %	± 0.2 %	± 0.1 %	± 0.3 %	± 0.2 %
Voids	± 1.2 %	± 1.0 %	± 1.2 %	± 1.0 %	± 1.2 %	± 1.0 %
VMA	-0.7 % ^{2/}	-0.5 % ^{2/}	-0.7 % ^{2/}	-0.5 % ^{2/}	-0.7 % ^{2/}	-0.5 % ^{2/}

1/ Based on washed ignition oven

2/ Allowable limit below minimum design VMA requirement

DENSITY CONTROL LIMITS		
Mixture Composition	Parameter	Individual Test
IL-4.75	Ndesign = 50	93.0 - 97.4 % ^{1/}
IL-9.5	Ndesign = 90	92.0 - 96.0 %
IL-9.5,IL-9.5L	Ndesign < 90	92.5 - 97.4 %
IL-19.0	Ndesign = 90	93.0 - 96.0 %
IL-19.0, IL-19.0L	Ndesign < 90	93.0 ^{2/} - 97.4 %
SMA	Ndesign = 50 & 80	93.5 - 97.4 %

1/ Density shall be determined by cores or by correlated, approved thin lift nuclear gauge.

2/ 92.0 % when placed as first lift on an unimproved subgrade.”

Revise the table in Article 1030.05(d)(5) of the Supplemental Specifications to read:

“CONTROL CHART REQUIREMENTS	High ESAL, Low ESAL, SMA & IL-4.75
Gradation ^{1/3/}	% Passing Sieves: 1/2 in. (12.5 mm) ^{2/} No. 4 (4.75 mm) No. 8 (2.36 mm) No. 30 (600 µm)
Total Dust Content ^{1/}	No. 200 (75 µm)
	Asphalt Binder Content
	Bulk Specific Gravity
	Maximum Specific Gravity of Mixture
	Voids
	Density
	VMA

1/ Based on washed ignition oven.

2/ Does not apply to IL-4.75.

3/ SMA also requires the 3/8 in. (9.5 mm) sieve.”

Delete Article 1030.05(d)(6)a.1.(b.) of the Standard Specifications.

Delete Article 1030.06(b) of the Standard Specifications.

Delete Article 1102.01(e) of the Standard Specifications.

80322

HOT-MIX ASPHALT – MIXTURE DESIGN VERIFICATION AND PRODUCTION (BDE)

Effective: November 1, 2013

Revised: November 1, 2014

Description. This special provision provides the requirements for Hamburg Wheel and tensile strength testing for High ESAL, IL-4.75, and Stone Matrix Asphalt (SMA) hot-mix asphalt (HMA) mixes during mix design verification and production. This special provision also provides the plant requirements for hydrated lime addition systems used in the production of High ESAL, IL-4.75, and SMA mixes.

Mix Design Testing. Add the following below the referenced AASHTO standards in Article 1030.04 of the Standard Specifications:

AASHTO T 324	Hamburg Wheel Test
AASHTO T 283	Tensile Strength Test

Add the following to Article 1030.04 of the Standard Specifications:

“(d) Verification Testing. High ESAL, IL-4.75, and SMA mix designs submitted for verification will be tested to ensure that the resulting mix designs will pass the required criteria for the Hamburg Wheel Test (Illinois Modified AASHTO T 324) and the Tensile Strength Test (Illinois Modified AASHTO T 283). The Department will perform a verification test on gyratory specimens compacted by the Contractor. If the mix fails the Department’s verification test, the Contractor shall make necessary changes to the mix and provide passing Hamburg Wheel and tensile strength test results from a private lab. The Department will verify the passing results.

All new and renewal mix designs shall meet the following requirements for verification testing.

(1) Hamburg Wheel Test Criteria. The maximum allowable rut depth shall be 0.5 in. (12.5 mm). The minimum number of wheel passes at the 0.5 in. (12.5 mm) rut depth criteria shall be based on the high temperature binder grade of the mix as specified in the mix requirements table of the plans.

Illinois Modified AASHTO T 324 Requirements ^{1/}

PG Grade	Number of Passes
PG 58-xx (or lower)	5,000
PG 64-xx	7,500
PG 70-xx	15,000
PG 76-xx (or higher)	20,000

1/ When produced at temperatures of 275 ± 5 °F (135 ± 3 °C) or less, loose Warm Mix Asphalt shall be oven aged at 270 ± 5 °F (132 ± 3 °C) for two hours prior to gyratory compaction of Hamburg Wheel specimens.

(2) Tensile Strength Criteria. The minimum allowable conditioned tensile strength shall be 60 psi (415 kPa) for non-polymer modified performance graded (PG) asphalt binder and 550 kPa (80 psi) for polymer modified PG asphalt binder. The maximum allowable unconditioned tensile strength shall be 200 psi (1380 kPa).”

Production Testing. Revise Article 1030.06(a) of the Standard Specifications to read:

“(a) High ESAL, IL-4.75, WMA, and SMA Mixtures. For each contract, a 300 ton (275 metric tons) test strip will be required at the beginning of HMA production for each mixture with a quantity of 3000 tons (2750 metric tons) or more according to the Manual of Test Procedures for Materials “Hot Mix Asphalt Test Strip Procedures”.

Before start-up, target values shall be determined by applying gradation correction factors to the JMF when applicable. These correction factors shall be determined from previous experience. The target values, when approved by the Engineer, shall be used to control HMA production. Plant settings and control charts shall be set according to target values.

Before constructing the test strip, target values shall be determined by applying gradation correction factors to the JMF when applicable. After any JMF adjustment, the JMF shall become the Adjusted Job Mix Formula (AJMF). Upon completion of the first acceptable test strip, the JMF shall become the AJMF regardless of whether or not the JMF has been adjusted. If an adjustment/plant change is made, the Engineer may require a new test strip to be constructed. If the HMA placed during the initial test strip is determined to be unacceptable to remain in place by the Engineer, it shall be removed and replaced.

The limitations between the JMF and AJMF are as follows.

Parameter	Adjustment
1/2 in. (12.5 mm)	± 5.0 %
No. 4 (4.75 mm)	± 4.0 %
No. 8 (2.36 mm)	± 3.0 %
No. 30 (600 μ m)	*
No. 200 (75 μ m)	*
Asphalt Binder Content	± 0.3 %

* In no case shall the target for the amount passing be greater than the JMF.

Any adjustments outside the above limitations will require a new mix design.

Mixture sampled to represent the test strip shall include additional material sufficient for the Department to conduct Hamburg Wheel testing according to Illinois Modified AASHTO T324 (approximately 60 lb (27 kg) total).

The Contractor shall immediately cease production upon notification by the Engineer of failing Hamburg Wheel test. All prior produced material may be paved out provided all other mixture criteria is being met. No additional mixture shall be produced until the Engineer receives passing Hamburg Wheel tests.

The Department may conduct additional Hamburg Wheel tests on production material as determined by the Engineer.”

Revise the title of Article 1030.06(b) of the Standard Specifications to read:

“(b) Low ESAL Mixtures.”

System for Hydrated Lime Addition. Revise the fourth sentence of the third paragraph of Article 1030.04(c) of the Standard Specifications to read:

“The method of application shall be according to Article 1102.01(a)(10).”

Replace the first three sentences of the second paragraph of Article 1102.01(a)(10) of the Standard Specifications to read:

“When hydrated lime is used as the anti-strip additive, a separate bin or tank and feeder system shall be provided to store and accurately proportion the lime onto the aggregate either as a slurry, as dry lime applied to damp aggregates, or as dry lime injected onto the hot aggregates prior to adding the liquid asphalt cement. If the hydrated lime is added either as a slurry or as dry lime on damp aggregates, the lime and aggregates shall be mixed by a power driven pugmill to provide a uniform coating of the lime prior to entering the dryer. If dry hydrated lime is added to the hot dry aggregates in a dryer-drum plant, the lime shall be added in such a manner that the lime will not become entrained into the air stream of the dryer-drum and that thorough dry mixing shall occur prior to the injection point of the liquid asphalt. When a batch plant is used, the hydrated lime shall be added to the mixture in the weigh hopper or as approved by the Engineer.”

Basis of Payment. Replace the seventh paragraph of Article 406.14 of the Standard Specifications with the following:

“For mixes designed and verified under the Hamburg Wheel criteria, the cost of furnishing and introducing anti-stripping additives in the HMA will not be paid for separately, but shall be considered as included in the contract unit price of the HMA item involved.

If an anti-stripping additive is required for any other HMA mix, the cost of the additive will be paid for according to Article 109.04. The cost incurred in introducing the additive into the

HMA will not be paid for separately, but shall be considered as included in the contract unit price of the HMA item involved.

No additional compensation will be awarded to the Contractor because of reduced production rates associated with the addition of the anti-stripping additive.”

80323

HOT MIX ASPHALT – PRIME COAT (BDE)

Effective: November 1, 2014

Revise Note 1 of Article 406.02 of the Standard Specifications to read:

“Note 1. The bituminous material used for prime coat shall be one of the types listed in the following table.

When emulsified asphalts are used, any dilution with water shall be performed by the emulsion producer. The emulsified asphalt shall be thoroughly agitated within 24 hours of application and show no separation of water and emulsion.

Application	Bituminous Material Types
Prime Coat on Brick, Concrete, or HMA Bases	SS-1, SS-1h, SS-1hP, SS-1vh, RS-1, RS-2, CSS-1, CSS-1h, CSS-1hp, CRS-1, CRS-2, HFE-90, RC-70
Prime Coat on Aggregate Bases	MC-30, PEP”

Add the following to Article 406.03 of the Standard Specifications.

- “(i) Vacuum Sweeper 1101.19
- “(j) Spray Paver 1102.06”

Revise Article 406.05(b) of the Standard Specifications to read:

“(b) Prime Coat. The bituminous material shall be prepared according to Article 403.05 and applied according to Article 403.10. The use of RC-70 shall be limited to air temperatures less than 60 °F (15 °C).

- (1) Brick, Concrete or HMA Bases. The base shall be cleaned of all dust, debris and any substance that will prevent the prime coat from adhering to the base. Cleaning shall be accomplished by sweeping to remove all large particles and air blasting to remove dust. As an alternative to air blasting, a vacuum sweeper may be used to accomplish the dust removal. The base shall be free of standing water at the time of application. The prime coat shall be applied uniformly and at a rate that will provide a residual asphalt rate on the prepared surface as specified in the following table.

Type of Surface to be Primed	Residual Asphalt Rate lb/sq ft (kg/sq m)
Milled HMA, Aged Non-Milled HMA, Milled Concrete, Non-Milled Concrete & Tined Concrete	0.05 (0.244)
Fog Coat between HMA Lifts, IL-4.75 & Brick	0.025 (0.122)

The bituminous material for the prime coat shall be placed one lane at a time. If a spray paver is not used, the primed lane shall remain closed until the prime coat is

fully cured and does not pickup under traffic. When placing prime coat through an intersection where it is not possible to keep the lane closed, the prime coat may be covered immediately following its application with fine aggregate mechanically spread at a uniform rate of 2 to 4 lb/sq yd (1 to 2 kg/sq m).

- (2) Aggregate Bases. The prime coat shall be applied uniformly and at a rate that will provide a residual asphalt rate on the prepared surface of 0.25 lb/sq ft \pm 0.01 (1.21 kg/sq m \pm 0.05).

The prime coat shall be permitted to cure until the penetration has been approved by the Engineer, but at no time shall the curing period be less than 24 hours for MC-30 or four hours for PEP. Pools of prime occurring in the depressions shall be broomed or squeegeed over the surrounding surface the same day the prime coat is applied.

The base shall be primed 1/2 width at a time. The prime coat on the second half/width shall not be applied until the prime coat on the first half/width has cured so that it will not pickup under traffic.

The residual asphalt rate will be verified a minimum of once per type of surface to be primed as specified herein for which at least 2000 tons (1800 metric tons) of HMA will be placed. The test will be according to the "Determination of Residual Asphalt in Prime and Tack Coat Materials" test procedure.

Prime coat shall be fully cured prior to placement of HMA to prevent pickup by haul trucks or paving equipment. If pickup occurs, paving shall cease in order to provide additional cure time, and all areas where the pickup occurred shall be repaired.

If after five days, loss of prime coat is evident prior to covering with HMA, additional prime coat shall be placed as determined by the Engineer at no additional cost to the Department."

Revise the last sentence of the first paragraph of Article 406.13(b) of the Standard Specifications to read:

"Water added to emulsified asphalt, as allowed in Article 406.02, will not be included in the quantities measured for payment."

Revise the second paragraph of Article 406.13(b) of the Standard Specifications to read:

"Aggregate for covering prime coat will not be measured for payment."

Revise the first paragraph of Article 406.14 of the Standard Specifications to read:

"406.14 Basis of Payment. Prime Coat will be paid for at the contract unit price per pound (kilogram) of residual asphalt applied for BITUMINOUS MATERIALS (PRIME COAT), or POLYMERIZED BITUMINOUS MATERIALS (PRIME COAT)."

Revise Article 407.02 of the Standard Specifications to read:

“407.02 Materials. Materials shall be according to Article 406.02, except as follows.

Item	Article/Section
(a) Packaged Rapid Hardening Mortar or Concrete	1018”

Revise Article 407.06(b) of the Standard Specifications to read:

“(b) A bituminous prime coat shall be applied between each lift of HMA according to Article 406.05(b).”

Delete the second paragraph of Article 407.12 of the Standard Specifications.

Revise the first paragraph of Article 408.04 of the Standard Specifications to read:

“408.04 Method of Measurement. Bituminous priming material will be measured for payment according to Article 406.13.”

Revise the first paragraph of Article 408.05 of the Standard Specifications to read:

“408.05 Basis of Payment. This work will be paid for at the contract unit price per pound (kilogram) of residual asphalt applied for BITUMINOUS MATERIALS (PRIME COAT) or POLYMERIZED BITUMINOUS MATERIALS (PRIME COAT) and at the contract unit price per ton (metric ton) for INCIDENTAL HOT-MIX ASPHALT SURFACING.”

Revise Article 1032.02 of the Standard Specifications to read:

“1032.02 Measurement. Asphalt binders, emulsified asphalts, rapid curing liquid asphalt, medium curing liquid asphalts, slow curing liquid asphalts, asphalt fillers, and road oils will be measured by weight.

A weight ticket for each truck load shall be furnished to the inspector. The truck shall be weighed at a location approved by the Engineer. The ticket shall show the weight of the empty truck (the truck being weighed each time before it is loaded), the weight of the loaded truck, and the net weight of the bituminous material.

When an emulsion or cutback is used for prime coat, the percentage of asphalt residue of the actual certified product shall be shown on the producer’s bill of lading or attached certificate of analysis. If the producer adds extra water to an emulsion at the request of the purchaser, the amount of water shall also be shown on the bill of lading.

Payment will not be made for bituminous materials in excess of 105 percent of the amount specified by the Engineer.”

Add the following to the table in Article 1032.04 of the Standard Specifications.

“SS-1vh	160-180	70-80
RS-1, CRS-1	75-130	25-55”

Add the following to Article 1032.06 of the Standard Specifications.

“(g) Non Tracking Emulsified Asphalt SS-1vh shall be according to the following.

Requirements for SS-1vh			
Test		SPEC	AASHTO Test Method
Saybolt Viscosity @ 25C,	SFS	20-200	T 72
Storage Stability, 24hr.,	%	1 max.	T 59
Residue by Evaporation,	%	50 min.	T 59
Sieve Test,	%	0.3 max.	T 59
Tests on Residue from Evaporation			
Penetration @25°C, 100g., 5 sec., dmm		20 max.	T 49
Softening Point,	°C	65 min.	T 53
Solubility,	%	97.5 min.	T 44
Orig. DSR @ 82°C,	kPa	1.00 min.	T 315”

Revise the last table in Article 1032.06(f)(2)d. of the Standard Specifications to read:

“Grade	Use
SS-1, SS-1h, RS-1, RS-2, CSS-1, CRS-1, CRS-2, CSS-1h, HFE-90, SS-1hP, CSS-1hP, SS-1vh	Prime or fog seal
PEP	Bituminous surface treatment prime
RS-2, HFE-90, HFE-150, HFE- 300, CRSP, HFP, CRS-2, HFRS-2	Bituminous surface treatment
CSS-1h Latex Modified	Microsurfacing”

Add the following to Article 1101 of the Standard Specifications.

“**1101.19 Vacuum Sweeper.** The vacuum sweeper shall have a minimum sweeping path of 52 in. (1.3 m) and a minimum blower rating of 20,000 cu ft per minute (566 cu m per minute).”

Add the following to Article 1102 of the Standard Specifications:

“**1102.06 Spray Paver.** The spreading and finishing machine shall be capable of spraying a rapid setting emulsion tack coat, paving a layer of HMA, and providing a smooth HMA mat in one pass. The HMA shall be spread over the tack coat in less than five seconds after the

application of the tack coat during normal paving speeds. No wheel or other part of the paving machine shall come into contact with the tack coat before the HMA is applied. In addition to meeting the requirements of Article 1102.03, the spray paver shall also meet the requirements of Article 1102.05 for the tank, heating system, pump, thermometer, tachometer or synchronizer, and calibration. The spray bar shall be equipped with properly sized and spaced nozzles to apply a uniform application of tack coat at the specified rate for the full width of the mat being placed.”

80348

RECLAIMED ASPHALT PAVEMENT AND RECLAIMED ASPHALT SHINGLES (BDE)

Effective: November 1, 2012

Revise: April 1, 2014

Revise Section 1031 of the Standard Specifications to read:

“SECTION 1031. RECLAIMED ASPHALT PAVEMENT AND RECLAIMED ASPHALT SHINGLES

1031.01 Description. Reclaimed asphalt pavement and reclaimed asphalt shingles shall be according to the following.

- (a) Reclaimed Asphalt Pavement (RAP). RAP is the material produced by cold milling or crushing an existing hot-mix asphalt (HMA) pavement. The Contractor shall supply written documentation that the RAP originated from routes or airfields under federal, state, or local agency jurisdiction.
- (b) Reclaimed Asphalt Shingles (RAS). Reclaimed asphalt shingles (RAS). RAS is from the processing and grinding of preconsumer or post-consumer shingles. RAS shall be a clean and uniform material with a maximum of 0.5 percent unacceptable material, as defined in Bureau of Materials and Physical Research Policy Memorandum “Reclaimed Asphalt Shingle (RAS) Sources”, by weight of RAS. All RAS used shall come from a Bureau of Materials and Physical Research approved processing facility where it shall be ground and processed to 100 percent passing the 3/8 in. (9.5 mm) sieve and 93 percent passing the #4 (4.75 mm) sieve based on a dry shake gradation. RAS shall be uniform in gradation and asphalt binder content and shall meet the testing requirements specified herein. In addition, RAS shall meet the following Type 1 or Type 2 requirements.
 - (1) Type 1. Type 1 RAS shall be processed, preconsumer asphalt shingles salvaged from the manufacture of residential asphalt roofing shingles.
 - (2) Type 2. Type 2 RAS shall be processed post-consumer shingles only, salvaged from residential, or four unit or less dwellings not subject to the National Emission Standards for Hazardous Air Pollutants (NESHAP).

1031.02 Stockpiles. RAP and RAS stockpiles shall be according to the following.

- (a) RAP Stockpiles. The Contractor shall construct individual, sealed RAP stockpiles meeting one of the following definitions. No additional RAP shall be added to the pile after the pile has been sealed. Stockpiles shall be sufficiently separated to prevent intermingling at the base. Stockpiles shall be identified by signs indicating the type as listed below (i.e. “Homogeneous Surface”).

Prior to milling, the Contractor shall request the District provide documentation on the quality of the RAP to clarify the appropriate stockpile.

- (1) Fractionated RAP (FRAP). FRAP shall consist of RAP from Class I, HMA (High and Low ESAL) mixtures. The coarse aggregate in FRAP shall be crushed aggregate and may represent more than one aggregate type and/or quality but shall be at least C quality. All FRAP shall be fractionated prior to testing by screening into a minimum of two size fractions with the separation occurring on or between the #4 (4.75 mm) and 1/2 in. (12.5 mm) sieves. Agglomerations shall be minimized such that 100 percent of the RAP shall pass the sieve size specified below for the mix into which the FRAP will be incorporated.

Mixture FRAP will be used in:	Sieve Size that 100% of FRAP Shall Pass
IL-25.0	2 in. (50 mm)
IL-19.0	1 1/2 in. (40 mm)
IL-12.5	1 in. (25 mm)
IL-9.5	3/4 in. (20 mm)
IL-4.75	1/2 in. (13 mm)

- (2) Homogeneous. Homogeneous RAP stockpiles shall consist of RAP from Class I, HMA (High and Low ESAL) mixtures and represent: 1) the same aggregate quality, but shall be at least C quality; 2) the same type of crushed aggregate (either crushed natural aggregate, ACBF slag, or steel slag); 3) similar gradation; and 4) similar asphalt binder content. If approved by the Engineer, combined single pass surface/binder millings may be considered "homogenous" with a quality rating dictated by the lowest coarse aggregate quality present in the mixture.
- (3) Conglomerate. Conglomerate RAP stockpiles shall consist of RAP from Class I, HMA (High and Low ESAL) mixtures. The coarse aggregate in this RAP shall be crushed aggregate and may represent more than one aggregate type and/or quality but shall be at least C quality. This RAP may have an inconsistent gradation and/or asphalt binder content prior to processing. All conglomerate RAP shall be processed prior to testing by crushing to where all RAP shall pass the 5/8 in. (16 mm) or smaller screen. Conglomerate RAP stockpiles shall not contain steel slag.
- (4) Conglomerate "D" Quality (DQ). Conglomerate DQ RAP stockpiles shall consist of RAP from Class I, HMA (High or Low ESAL), or "All Other" (as defined by Article 1030.04(a)(3)) mixtures. The coarse aggregate in this RAP may be crushed or round but shall be at least D quality. This RAP may have an inconsistent gradation and/or asphalt binder content. Conglomerate DQ RAP stockpiles shall not contain steel slag.
- (5) Non-Quality. RAP stockpiles that do not meet the requirements of the stockpile categories listed above shall be classified as "Non-Quality".

RAP/FRAP containing contaminants, such as earth, brick, sand, concrete, sheet asphalt, bituminous surface treatment (i.e. chip seal), pavement fabric, joint sealants, etc., will be unacceptable unless the contaminants are removed to the satisfaction of the Engineer. Sheet asphalt shall be stockpiled separately.

- (b) RAS Stockpiles. Type 1 and Type 2 RAS shall be stockpiled separately and shall not be intermingled. Each stockpile shall be signed indicating what type of RAS is present.

Unless otherwise specified by the Engineer, mechanically blending manufactured sand (FM 20 or FM 22) up to an equal weight of RAS with the processed RAS will be permitted to improve workability. The sand shall be "B Quality" or better from an approved Aggregate Gradation Control System source. The sand shall be accounted for in the mix design and during HMA production.

Records identifying the shingle processing facility supplying the RAS, RAS type and lot number shall be maintained by project contract number and kept for a minimum of three years.

1031.03 Testing. RAP/FRAP and RAS testing shall be according to the following.

- (a) RAP/FRAP Testing. When used in HMA, the RAP/FRAP shall be sampled and tested either during or after stockpiling.

- (1) During Stockpiling. For testing during stockpiling, washed extraction samples shall be run at the minimum frequency of one sample per 500 tons (450 metric tons) for the first 2000 tons (1800 metric tons) and one sample per 2000 tons (1800 metric tons) thereafter. A minimum of five tests shall be required for stockpiles less than 4000 tons (3600 metric tons).

- (2) After Stockpiling. For testing after stockpiling, the Contractor shall submit a plan for approval to the District proposing a satisfactory method of sampling and testing the RAP/FRAP pile either in-situ or by restockpiling. The sampling plan shall meet the minimum frequency required above and detail the procedure used to obtain representative samples throughout the pile for testing.

Each sample shall be split to obtain two equal samples of test sample size. One of the two test samples from the final split shall be labeled and stored for Department use. The Contractor shall extract the other test sample according to Department procedure. The Engineer reserves the right to test any sample (split or Department-taken) to verify Contractor test results.

- (b) RAS Testing. RAS or RAS blended with manufactured sand shall be sampled and tested during stockpiling according to Illinois Department of Transportation Policy Memorandum, "Reclaimed Asphalt Shingle (RAS) Source".

Samples shall be collected during stockpiling at the minimum frequency of one sample per 200 tons (180 metric tons) for the first 1000 tons (900 metric tons) and one sample per 250 tons (225 metric tons) thereafter. A minimum of five samples are required for stockpiles less than 1000 tons (900 metric tons). Once a ≤ 1000 ton (900 metric ton), five-sample/test stockpile has been established it shall be sealed. Additional incoming RAS or RAS blended with manufactured sand shall be stockpiled in a separate working pile as designated in the Quality Control plan and only added to the sealed stockpile when the test results of the working pile are complete and are found to meet the tolerances specified herein for the original sealed RAS stockpile.

Before testing, each sample shall be split to obtain two test samples. One of the two test samples from the final split shall be labeled and stored for Department use. The Contractor shall perform a washed extraction and test for unacceptable materials on the other test sample according to Department procedures. The Engineer reserves the right to test any sample (split or Department-taken) to verify Contractor test results.

If the sampling and testing was performed at the shingle processing facility in accordance with the QC Plan, the Contractor shall obtain and make available all of the test results from start of the initial stockpile.

1031.04 Evaluation of Tests. Evaluation of tests results shall be according to the following.

- (a) Evaluation of RAP/FRAP Test Results. All of the extraction results shall be compiled and averaged for asphalt binder content and gradation and, when applicable G_{mm} . Individual extraction test results, when compared to the averages, will be accepted if within the tolerances listed below.

Parameter	FRAP/Homogeneous /Conglomerate	Conglomerate "D" Quality
1 in. (25 mm)		$\pm 5 \%$
1/2 in. (12.5 mm)	$\pm 8 \%$	$\pm 15 \%$
No. 4 (4.75 mm)	$\pm 6 \%$	$\pm 13 \%$
No. 8 (2.36 mm)	$\pm 5 \%$	
No. 16 (1.18 mm)		$\pm 15 \%$
No. 30 (600 μ m)	$\pm 5 \%$	
No. 200 (75 μ m)	$\pm 2.0 \%$	$\pm 4.0 \%$
Asphalt Binder	$\pm 0.4 \%$ ^{1/}	$\pm 0.5 \%$
G_{mm}	± 0.03	

1/ The tolerance for FRAP shall be $\pm 0.3 \%$.

If more than 20 percent of the individual sieves and/or asphalt binder content tests are out of the above tolerances, the RAP/FRAP shall not be used in HMA unless the

RAP/FRAP representing the failing tests is removed from the stockpile. All test data and acceptance ranges shall be sent to the District for evaluation.

With the approval of the Engineer, the ignition oven may be substituted for extractions according to the Illinois Test Procedure, "Calibration of the Ignition Oven for the Purpose of Characterizing Reclaimed Asphalt Pavement (RAP)".

- (b) Evaluation of RAS and RAS Blended with Manufactured Sand Test Results. All of the test results, with the exception of percent unacceptable materials, shall be compiled and averaged for asphalt binder content and gradation. Individual test results, when compared to the averages, will be accepted if within the tolerances listed below.

Parameter	RAS
No. 8 (2.36 mm)	± 5 %
No. 16 (1.18 mm)	± 5 %
No. 30 (600 µm)	± 4 %
No. 200 (75 µm)	± 2.0 %
Asphalt Binder Content	± 1.5 %

If more than 20 percent of the individual sieves and/or asphalt binder content tests are out of the above tolerances, or if the percent unacceptable material exceeds 0.5 percent by weight of material retained on the # 4 (4.75 mm) sieve, the RAS or RAS blend shall not be used in Department projects. All test data and acceptance ranges shall be sent to the District for evaluation.

1031.05 Quality Designation of Aggregate in RAP/FRAP.

- (a) RAP. The aggregate quality of the RAP for homogenous, conglomerate, and conglomerate "D" quality stockpiles shall be set by the lowest quality of coarse aggregate in the RAP stockpile and are designated as follows.
- (1) RAP from Class I, Superpave/HMA (High ESAL), or (Low ESAL) IL-9.5L surface mixtures are designated as containing Class B quality coarse aggregate.
 - (2) RAP from Superpave/HMA (Low ESAL) IL-19.0L binder mixture is designated as Class D quality coarse aggregate.
 - (3) RAP from Class I, Superpave/HMA (High ESAL) binder mixtures, bituminous base course mixtures, and bituminous base course widening mixtures are designated as containing Class C quality coarse aggregate.
 - (4) RAP from bituminous stabilized subbase and BAM shoulders are designated as containing Class D quality coarse aggregate.
- (b) FRAP. If the Engineer has documentation of the quality of the FRAP aggregate, the Contractor shall use the assigned quality provided by the Engineer.

If the quality is not known, the quality shall be determined as follows. Coarse and fine FRAP stockpiles containing plus #4 (4.75 mm) sieve coarse aggregate shall have a maximum tonnage of 5,000 tons (4,500 metric tons). The Contractor shall obtain a representative sample witnessed by the Engineer. The sample shall be a minimum of 50 lb (25 kg). The sample shall be extracted according to Illinois Modified AASHTO T 164 by a consultant prequalified by the Department for the specified testing. The consultant shall submit the test results along with the recovered aggregate to the District Office. The cost for this testing shall be paid by the Contractor. The District will forward the sample to the BMPR Aggregate Lab for MicroDeval Testing, according to Illinois Modified AASHTO T 327. A maximum loss of 15.0 percent will be applied for all HMA applications.

1031.06 Use of RAP/FRAP and/or RAS in HMA. The use of RAP/FRAP and/or RAS shall be a Contractor's option when constructing HMA in all contracts.

(a) RAP/FRAP. The use of RAP/FRAP in HMA shall be as follows.

- (1) Coarse Aggregate Size. The coarse aggregate in all RAP shall be equal to or less than the nominal maximum size requirement for the HMA mixture to be produced.
- (2) Steel Slag Stockpiles. Homogeneous RAP stockpiles containing steel slag will be approved for use in all HMA (High ESAL and Low ESAL) Surface and Binder Mixture applications.
- (3) Use in HMA Surface Mixtures (High and Low ESAL). RAP/FRAP stockpiles for use in HMA surface mixtures (High and Low ESAL) shall be FRAP or homogeneous in which the coarse aggregate is Class B quality or better. RAP/FRAP from Conglomerate stockpiles shall be considered equivalent to limestone for frictional considerations. Known frictional contributions from plus #4 (4.75 mm) homogeneous RAP and FRAP stockpiles will be accounted for in meeting frictional requirements in the specified mixture.
- (4) Use in HMA Binder Mixtures (High and Low ESAL), HMA Base Course, and HMA Base Course Widening. RAP/FRAP stockpiles for use in HMA binder mixtures (High and Low ESAL), HMA base course, and HMA base course widening shall be FRAP, homogeneous, or conglomerate, in which the coarse aggregate is Class C quality or better.
- (5) Use in Shoulders and Subbase. RAP/FRAP stockpiles for use in HMA shoulders and stabilized subbase (HMA) shall be FRAP, homogeneous, conglomerate, or conglomerate DQ.
- (6) When the Contractor chooses the RAP option, the percentage of RAP shall not exceed the amounts indicated in Article 1031.06(c)(1) below for a given N Design.

- (b) RAS. RAS meeting Type 1 or Type 2 requirements will be permitted in all HMA applications as specified herein.
- (c) RAP/FRAP and/or RAS Usage Limits. Type 1 or Type 2 RAS may be used alone or in conjunction with RAP or FRAP in HMA mixtures up to a maximum of 5.0% by weight of the total mix.
- (1) RAP/RAS. When RAP is used alone or RAP is used in conjunction with RAS, the percentage of virgin asphalt binder replacement shall not exceed the amounts listed in the Max RAP/RAS ABR table listed below for the given Ndesign.

RAP/RAS Maximum Asphalt Binder Replacement (ABR) Percentage

HMA Mixtures ^{1/, 2/}	RAP/RAS Maximum ABR %		
Ndesign	Binder/Leveling Binder	Surface	Polymer Modified
30	30	30	10
50	25	15	10
70	15	10	10
90	10	10	10
105	10	10	10

1/ For HMA “All Other” (shoulder and stabilized subbase) N-30, the RAP/RAS ABR shall not exceed 50 percent of the mixture.

2/ When RAP/RAS ABR exceeds 20 percent, the high and low virgin asphalt binder grades shall each be reduced by one grade (i.e. 25 percent ABR would require a virgin asphalt binder grade of PG64-22 to be reduced to a PG58-28). If warm mix asphalt (WMA) technology is utilized, and production temperatures do not exceed 275 °F (135 °C) the high and low virgin asphalt binder grades shall each be reduced by one grade when RAP/RAS ABR exceeds 25 percent (i.e. 26 percent RAP/RAS ABR would require a virgin asphalt binder grade of PG64-22 to be reduced to a PG58-28).

(2) FRAP/RAS. When FRAP is used alone or FRAP is used in conjunction with RAS, the percentage of virgin asphalt binder replacement shall not exceed the amounts listed in the FRAP/RAS table listed below for the given N design.

FRAP/RAS Maximum Asphalt Binder Replacement (ABR) Percentage

HMA Mixtures ^{1/, 2/}	FRAP/RAS Maximum ABR %		
Ndesign	Binder/Leveling Binder	Surface	Polymer Modified ^{3/, 4/}
30	50	40	10

50	40	35	10
70	40	30	10
90	40	30	10
105	40	30	10

- 1/ For HMA "All Other" (shoulder and stabilized subbase) N30, the FRAP/RAS ABR shall not exceed 50 percent of the mixture.
- 2/ When FRAP/RAS ABR exceeds 20 percent for all mixes the high and low virgin asphalt binder grades shall each be reduced by one grade (i.e. 25 percent ABR would require a virgin asphalt binder grade of PG64-22 to be reduced to a PG58-28). If warm mix asphalt (WMA) technology is utilized, and production temperatures do not exceed 275 °F (135 °C) the high and low virgin asphalt binder grades shall each be reduced by one grade when FRAP/RAS ABR exceeds 25 percent (i.e. 26 percent ABR would require a virgin asphalt binder grade of PG64-22 to be reduced to a PG58-28).
- 3/ For SMA the FRAP/RAS ABR shall not exceed 20 percent.
- 4/ For IL-4.75 mix the FRAP/RAS ABR shall not exceed 30 percent.

1031.07 HMA Mix Designs. At the Contractor's option, HMA mixtures may be constructed utilizing RAP/FRAP and/or RAS material meeting the detailed requirements specified herein.

- (a) RAP/FRAP and/or RAS. RAP/FRAP and/or RAS mix designs shall be submitted for verification. If additional RAP/FRAP stockpiles are tested and found that no more than 20 percent of the results, as defined under "Testing" herein, are outside of the control tolerances set for the original RAP/FRAP stockpile and HMA mix design, and meets all of the requirements herein, the additional RAP/FRAP stockpiles may be used in the original mix design at the percent previously verified.
- (b) RAS. Type 1 and Type 2 RAS are not interchangeable in a mix design. A RAS stone bulk specific gravity (Gsb) of 2.500 shall be used for mix design purposes.

1031.08 HMA Production. HMA production utilizing RAP/FRAP and/or RAS shall be as follows.

- (a) RAP/FRAP. The coarse aggregate in all RAP/FRAP used shall be equal to or less than the nominal maximum size requirement for the HMA mixture being produced.

To remove or reduce agglomerated material, a scalping screen, gator, crushing unit, or comparable sizing device approved by the Engineer shall be used in the RAP feed system to remove or reduce oversized material. If material passing the sizing device adversely affects the mix production or quality of the mix, the sizing device shall be set at a size specified by the Engineer.

If the RAP/FRAP control tolerances or QC/QA test results require corrective action, the Contractor shall cease production of the mixture containing RAP/FRAP and either switch to the virgin aggregate design or submit a new RAP/FRAP design.

(b) RAS. RAS shall be incorporated into the HMA mixture either by a separate weight depletion system or by using the RAP weigh belt. Either feed system shall be interlocked with the aggregate feed or weigh system to maintain correct proportions for all rates of production and batch sizes. The portion of RAS shall be controlled accurately to within ± 0.5 percent of the amount of RAS utilized. When using the weight depletion system, flow indicators or sensing devices shall be provided and interlocked with the plant controls such that the mixture production is halted when RAS flow is interrupted.

(c) RAP/FRAP and/or RAS. HMA plants utilizing RAP/FRAP and/or RAS shall be capable of automatically recording and printing the following information.

(1) Dryer Drum Plants.

- a. Date, month, year, and time to the nearest minute for each print.
- b. HMA mix number assigned by the Department.
- c. Accumulated weight of dry aggregate (combined or individual) in tons (metric tons) to the nearest 0.1 ton (0.1 metric ton).
- d. Accumulated dry weight of RAP/FRAP/RAS in tons (metric tons) to the nearest 0.1 ton (0.1 metric ton).
- e. Accumulated mineral filler in revolutions, tons (metric tons), etc. to the nearest 0.1 unit.
- f. Accumulated asphalt binder in gallons (liters), tons (metric tons), etc. to the nearest 0.1 unit.
- g. Residual asphalt binder in the RAP/FRAP material as a percent of the total mix to the nearest 0.1 percent.
- h. Aggregate and RAP/FRAP moisture compensators in percent as set on the control panel. (Required when accumulated or individual aggregate and RAP/FRAP are printed in wet condition.)

(2) Batch Plants.

- a. Date, month, year, and time to the nearest minute for each print.
- b. HMA mix number assigned by the Department.

- c. Individual virgin aggregate hot bin batch weights to the nearest pound (kilogram).
- d. Mineral filler weight to the nearest pound (kilogram).
- e. RAP/FRAP/RAS weight to the nearest pound (kilogram).
- f. Virgin asphalt binder weight to the nearest pound (kilogram).
- g. Residual asphalt binder in the RAP/FRAP/RAS material as a percent of the total mix to the nearest 0.1 percent.

The printouts shall be maintained in a file at the plant for a minimum of one year or as directed by the Engineer and shall be made available upon request. The printing system will be inspected by the Engineer prior to production and verified at the beginning of each construction season thereafter.

1031.09 RAP in Aggregate Surface Course and Aggregate Shoulders. The use of RAP in aggregate surface course (temporary access entrances only) and aggregate wedge shoulders Type B shall be as follows.

- (a) Stockpiles and Testing. RAP stockpiles may be any of those listed in Article 1031.02, except "Non-Quality" and "FRAP". The testing requirements of Article 1031.03 shall not apply. RAP used to construct aggregate surface course and aggregate shoulders shall be according to the current Bureau of Materials and Physical Research's Policy Memorandum, "Reclaimed Asphalt Pavement (RAP) for Aggregate Applications".
- (b) Gradation. One hundred percent of the RAP material shall pass the 1 1/2 in. (37.5 mm) sieve. The RAP material shall be reasonably well graded from coarse to fine. RAP material that is gap-graded or single sized will not be accepted."